

RACE

PERFORMANCE

ALLRIDE

FREESKI

WOMEN

JUNIOR

RENTAL





RACE

**WHEN YOU ONLY TAKE OFF
YOUR SKIS TO CLIMB THE
PODIUM. WHEN YOU CAN
TURN YOUR BLOOD, SWEAT
AND TEARS INTO GOLD.
WHEN THE ONLY OPPONENT
TO BEAT IS YOU.
WHAT'S YOUR LIMIT?**

Winning isn't just about being faster or stronger than everyone else. Winning is about not giving up, about never being discouraged and never quite satisfied. It's about winning all the little everyday battles in preparation for the big ones. Winners win against themselves first, transcending their inhibitions and pushing their limits, then they win against others.

WINNERS GIVE EVERYTHING – AND IN RETURN, WE GET IT ALL.

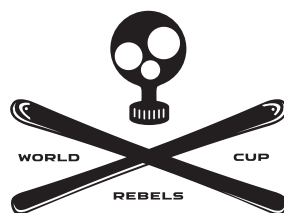

SKI TECHNOLOGY | KERS



THE EXTRA BOOST

KERS Technology works like a turbo charger that provides additional power and acceleration by stiffening the tail of the ski in outturns.

THE EFFECT: A BOOST, CATAPULTING THE RIDER INTO THE NEXT TURN.

Just like when Formula 1 pilots push a button for that extra notch of Speed. HEAD KERS Technology is an electronic, fully automatic and integrated system.

TECHNICAL BACKGROUND

HEAD KERS Technology is an evolution of the idea behind HEAD's Intelligence™ Technology. But unlike Intelligence™, KERS does not influence the torsional stiffness of the ski, KERS empowers the skis' longitudinal flex. Also KERS Technology is based on a completely new chip capable of accumulating power and keeping it in store for the right moment.

Piezoelectric fibers transform kinetic energy into electrical energy which is stored in the embedded chip in the ski. Electrical energy is immediately released to areas of the ski, where

additional energy is requested by the sensor. Timing and release are automatically controlled and coordinated. Depending on the flex pattern of different ski models, sensors are programmed beforehand: the more aggressive the ski has to be, the stiffer the tail will become.

Skis experience maximum flex at the end of a turn. At this moment an active microchip releases energy into the fibers of the tail. The tail of the ski then stiffens up, immediately increasing rebound for maximum acceleration at the end of the outturn.

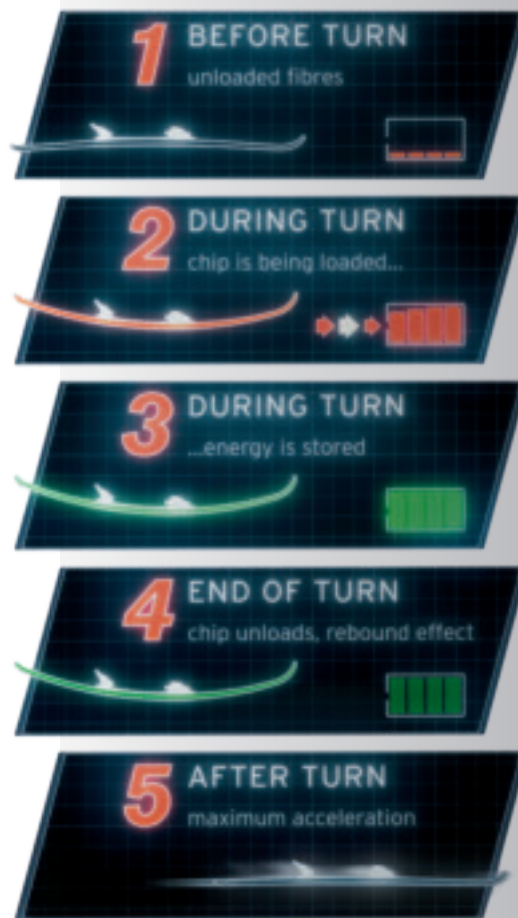

BINDING TECHNOLOGY | FREEFLEX

FREEFLEX PRO

Presenting the innovative Freeflex Pro System we focus on a new level of performance: Due to reduced stand height the gliding band is much closer to the ski boot, and our free-gliding heel allows the ski to flex unimpeded. This ensures consistent release values, reduced risk of injury and even more power and precision steering your skis.

RACE PRO HEEL

The reduced stand height corresponds to the FIS regulations. This gave us the opportunity to redesign the heel track, making it 1 mm higher and 8 mm wider for even more stability and direct power transmission. Moreover, increased size of the gliding inserts reduces friction and provides even smoother and more consistent release performance in all skiing situations and conditions.

DIAGONAL TOE

Full Diagonal Toes feature 180° release action both horizontally and vertically. Maximum safety in backward twisting-fall situations. Race Diagonal Toes are tuned for racing purposes. Due to higher release force vertically than horizontally, it holds up to the high backward lean forces in racing.

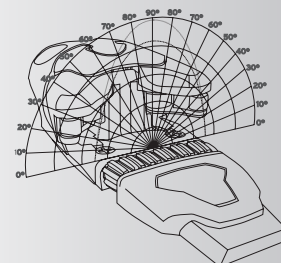
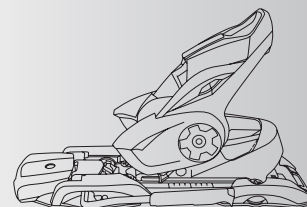
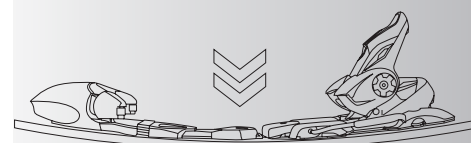



WORLD CUP REBELS i.GS RD

ART.N°: 310003

FEATURES:



- KERS
- Intelligence Technology
- WC sandwich construction
- RD racing top sheet
- Race structured high speed UHM C base
- Rebel Camber
- FIS approved for Continental Cup and Masters

LENGTHS:

175/178/183

DIMENSIONS:

104/68/89 @ length 183

RADIUS:

25,4 @ length 183

SKILLS:

Level **■■■** Speed **■■■**

PLATES:

HEAD Race Plate RDX

BINDINGS:

ART.N°: 100501 Freeflex Pro 20 X RS



WORLD CUP REBELS i.GS RD M/W

FEATURES:



- KERS
- Intelligence Technology
- WC sandwich construction
- RD racing top sheet
- Race structured high speed UHM C base
- Rebel Camber
- FIS approved for World Cup and European Cup only

LENGTHS:

190/195 ART.N°: 310093

183/188 ART.N°: 310103

DIMENSIONS:

98/65/81 @ length 195

101/65/82 @ length 188

RADIUS:

35,0 @ length 195

30,0 @ length 188

SKILLS:

Level **■■■** Speed **■■■**

PLATES:

HEAD Race Plate RDX

BINDINGS:

ART.N°: 100500 Freeflex Pro 20 X RD



WORLD CUP REBELS i.SL RD

ART.N°: 310033

FEATURES:



- KERS
- Intelligence Technology
- WC sandwich construction
- RD racing top sheet
- Race structured high speed UHM C base
- Rebel Camber
- FIS approved

LENGTHS:

155/160/165

DIMENSIONS:

117/66/100 @ length 165

RADIUS:

13,0 @ length 165

SKILLS:

Level **■■■** Speed **■■■**

PLATES:

HEAD Race Plate RDX

BINDINGS:

ART.N°: 100502 Freeflex Pro 18 X



WORLD CUP REBELS i.DH RD

FEATURES:



- KERS
- Intelligence Technology
- WC sandwich construction
- RD racing top sheet
- Race structured high speed UHM C base
- Rebel Camber
- FIS approved

SPECS:

Art.N°	Length	Dimension	Radius
319903	218	92/65/80	50
319913	210	91/65/78	50

SKILLS:

Level **III** Speed **III**

PLATES:

HEAD Race Plate RDX

BINDINGS:

ART.N°: **100500** Freeflex Pro 20 X RD



WORLD CUP REBELS i.SG RD

FEATURES:



- KERS
- Intelligence Technology
- WC sandwich construction
- RD racing top sheet
- Race structured high speed UHM C base
- Rebel Camber
- FIS approved

SPECS:

Art.N°	Length	Dimension	Radius
319923	213	95/65/79 (men's constr.)	45,0
319933	207	95/65/80 (women's constr.)	42,0
319983	207	93,5/65/78 (men's constr.)	45,5
319993	202	95/65/79 (women's constr.)	40,5

SKILLS:

Level **III** Speed **III**

PLATES:

HEAD Race Plate RDX

BINDINGS:

ART.N°: **100500** Freeflex Pro 20 X RD



WORLD CUP REBELS i.SL

ART.N°: 310043

FEATURES:



- KERS
- Intelligence Technology
- Race structured UHM C base
- WC sandwich construction
- Rebel Camber

LENGTHS:

150/155/160/165/170

DIMENSIONS:

122/66/107 @ length 165

RADIUS:

11,5 @ length 165

SKILLS:

Level ■ ■ ■ Speed ■ ■ ■

PLATES:

Speedflex Plate 13

BINDINGS:

ART.N°: 100508 Freeflex Pro 14



WORLD CUP REBELS i.SPEED

ART.N°: 310063

FEATURES:



- KERS
- Intelligence Technology
- Race structured UHM C base
- WC sandwich construction
- Rebel Camber

LENGTHS:

165/170/175/180/185

DIMENSIONS:

112/66/94 @ length 180

RADIUS:

18,0 @ length 180

SKILLS:

Level ■ ■ ■ Speed ■ ■ ■

PLATES:

Speedflex Plate 13

BINDINGS:

ART.N°: 100508 Freeflex Pro 14



BOOT TECHNOLOGY | RAPTOR

DOUBLE POWER BOOSTER VELCRO

The strap of the Double Power Booster Velcro works as a double pulley for better closure and a tighter wrapping on the cuff. The elastic Booster Strap allows more dynamical response of the boot.

The result: more precise transmission and faster ski reaction. (Manufactured under license from Skimetrix Ltd.)

Protected under one or more of the following:
European patent N. 1087676, US patent N. 6.026.594
Canadian patent N. 2.335.698. Other patents pending.



SPINEFLEX BUCKLES

Spineflex is a revolutionary buckle concept with a flexible element and a constant closure point. The flexible element allows the buckle to adapt to the shell profile and thus provide a homogeneous foot wrapping independent from the degree of closure. The increased precision and comfort created from the absence of pressure points results in better performance.

SPINEFLEX BUCKLE



Light closure



Strong closure

NORMAL BUCKLE



Light closure



Strong closure

BOOTS

RAPTOR B2

ART.N°: 603002



LINER:

- Racing Pro liner
- Adjustable tongue
- Lacing option
- Racing footbed
- 40mm Double Power Booster velcro strap

BUCKLES:

- 4 screwed micro-adjustable Spineflex racing Dpt. alloy buckles

FEATURES:

- Flex stance performance tuning
- Double canting
- Rear support tuning
- Racing spoiler
- RD slalom kit
- FIS approved sole thickness

LEVEL:

Athlete

FLEX INDEX:

160/150/140

SIZES:

235 – 245 – ... – 285

SHELL:

PU

LAST:

RD 1500cc

LAST	91	93	95
SIZE	25.5	26.5	27.5

COLOR:

White



RAPTOR B3

ART.N°: 603004

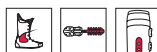

LINER:

- Racing Pro liner
- Adjustable tongue
- Lacing option
- Racing footbed
- 40mm Double Power Booster velcro strap

BUCKLES:

- 4 screwed micro-adjustable Spineflex racing Dpt. alloy buckles

FEATURES:

- Flex stance performance tuning
- Double canting
- Rear support tuning
- Racing spoiler
- RD slalom kit
- FIS approved sole thickness

LEVEL:

Athlete

FLEX INDEX:

140/130/120

SIZES:

235 – 245 – ... – 285

SHELL:

PU

LAST:

RD 1500cc

LAST	91	93	95
SIZE	25.5	26.5	27.5

COLOR:

White

BOOTS

RAPTOR 130

ART.N°: 603007



LINER:

- Performance Pro liner
- HP frame footbed
- 40mm Double Power Booster velcro strap

BUCKLES:

- 4 micro-adjustable Spineflex racing alloy buckles

FEATURES:

- Flex stance performance tuning
- Double canting
- Rear support tuning
- FIS approved sole thickness
- Low racing wedge

LEVEL:

Professional

FLEX INDEX:

140/130/120

SIZES:

230 - 240 - 250 - ... - 305

SHELL:

PU

LAST:

RS 1800cc

LAST	94	96	98
SIZE	25.5	26.5	27.5

COLOR:

White



RAPTOR 115

ART.N°: 603010



LINER:

- HeatFit Pro Liner
- HP frame footbed
- 40mm velcro strap

BUCKLES:

- 4 micro-adjustable Spine-Tech alloy buckles

FEATURES:

- Racing flex tuning
- Double canting
- FIS approved sole thickness
- Low racing wedge

LEVEL:

Professional

FLEX INDEX:

115/105

SIZES:

230 - 240 - 250 - ... - 305

SHELL:

PU

LAST:

RS 1800cc

LAST	94	96	98
SIZE	25.5	26.5	27.5

COLOR:

White

TUNING SYSTEM

TUNING KIT RACING

ART.N°: 60117427



INNERBOOT FOAM PRO

ART.N°: 60115746



HEEL/TOE LIFTERS 3MM

ART.N°: 60115023



HEEL/TOE LIFTERS 5MM

ART.N°: 60115024



KIT SPOILER REAR CUFF

ART.N°: 60113605



KIT SL RACING

ART.N°: 60115754

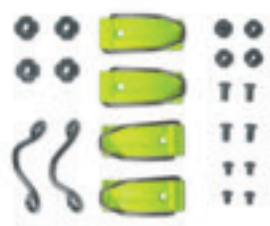

POLES



WORLD CUP SUPER G

ART.N°: 381023

COLOR:

White/Black/Yellow

DIAMETER Ø:

18mm

LENGTHS:

110 – 135 cm

FEATURES:

- 7075 Aluminum
- Soft downhill grip
- 40mm race strap
- DH and SG cone basket
- Carbide tip



WORLD CUP SL

ART.N°: 381033

COLOR:

Black/White/Yellow

DIAMETER Ø:

18mm

LENGTHS:

110 – 140 cm

FEATURES:

- 7075 Aluminum
- Soft downhill grip
- 50mm race basket
- Race strap
- Carbide tip



HELMETS

STIVOT RACE

Our full-shell race helmet STIVOT RACE is built to impress with not only a perfectly fitted form, but also an aerodynamically optimised shape, which leads to amazingly low noise levels at high speed.

FEATURES:

- DH/SG racing helmet
- Metal buckle
- Beanie liner
- Chinguard compatible

SIZES AND WEIGHTS:

XS (545g), S (555g), M (610g),
L (620g), XL (670g), XXL (680g)

COLORS:

White
Lime

ART.N°: 320303

ART.N°: 320313



White



Lime



SLALOM RACING CHINGUARD

ART.N°: 376103

FEATURES:

- Compatible with all
STIVOT RACE helmets

SIZES:

XS/S, M/L, XL/XXL



GOGGLES

HORIZON RACE

Perfect fit, optimum comfort and a fully unrestricted field of vision mark HEAD's latest development in racing goggles.

Thanks to the new FRAME LENS design, the horizontal field of vision extends upwards by up to 20% compared to conventionally designed goggles. The enlarged field of vision, called the TUCKSPHERE, makes it possible for racers to adopt a lower tuck position without disruptively restricting their field of vision a clear advantage, particularly in its aerodynamic effect.

The double lens, which is quickly and easily replaceable using the Speed SNAP system, offers 100% UV protection. The highly robust and light polycarbonate lens material provides protection from mechanical stresses.

FEATURES:

- Sprayed polycarbonate lens for maximum safety
- UV 400 protection & anti-fog
- Double lens
- Triple-layer foam
- Silicon layer
- Extrem wide field of vision
- Compatible with HEAD helmets
- Inclusive spare lens

COLORS:

White	ART.N°: 373313
Lime	ART.N°: 373323



GOGGLE TECHNOLOGY | HEAD FIELD OF VIEW

HEAD FIELD OF VIEW

The unique FRAME LENS structure expands the maximum field of vision to the highest level. This is very important for many reasons, all up front: maximum sight in the tuck position – THE TUCKSPHERE.

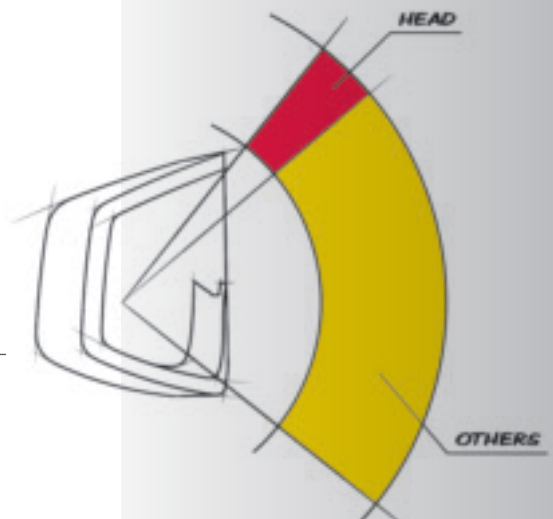

GOGGLES

HORIZON LENS KIT

The optional LENS KIT for our HORIZON series goggles, developed in close collaboration with our racers, contains four additional lenses. The LENS KIT's alternative lenses provide ideal coverage for a wide spectrum of light levels. The percentage VLT (Visible Light Transmission)

specifies how much of the visible daylight is filtered through to the eyes – a higher percentage therefore indicates a lower light blocking effect, while lenses with lower VLT block out more light and are designed for use in brighter conditions.



Clear lens



Yellow lens



Orange lens



Fire brown lens

ART.N°: 373953

DESCRIPTION	WEATHER	CATEGORY	UV PROTECTION	PERCENTAGE VLT	RECOMMENDED USAGE	POUCHE
Clear lens		CAT 0	UV 400	87%	enhanced contrast, suitable in changing weather conditions	X
Yellow lens		CAT 2	UV 400	32,99%	suitable in sunny/bright weather conditions	X
Orange lens		CAT 2	UV 400	24,48%	enhanced contrast, suitable in changing weather conditions	X
Fire brown lens		CAT 3	UV 400	10,32%	increased contrast, good against glare from snow, for sunny/bright conditions (incl. summer skiing), absorbing harmful blue UV rays up to 480 nm	X

PROTECTION

FLEXOR UNIT RACE

The FLEXOR UNIT RACE is highly customisable with an extra-wide waist strap and size-adjustable SHOULDER and CONNECTOR STRAPS, and it also provides ultimate comfort and protection. In addition, the removable SHOULDER STRAPS make the UNIT FIS-compliant and suitable for racing use.

ART.N°: 395323

FEATURES:

- Perfectly dampening and highly energy absorbing with SAS TEC viscoelastic foam
- Antibacterial and odor-freeness life guarantee with Polygiene 
- Removable protection unit
- FIS compatible with removable shoulder straps
- Height adjustable trouser connector straps

SIZES:

S – XXL



Unisex | Front



Unisex | Back

APPAREL

ALL MATERIALS: 82% Polyester, 14% Elasthan, 4% Polyurethan



RACING SOFTSHELL JACKET

ART.N°: 829333

FEATURES:

- 2 side pockets
- Chest pocket
- 10.000 mm water column
- 10.000g/m²/24 h breathability

COLORS:

Black/White/Race yellow

SIZES:

XS – XXL



RACING SOFTSHELL VEST

ART.N°: 829343

FEATURES:

- 2 side pockets
- Chest pocket
- 10.000 mm water column
- 10.000g/m²/24 h breathability

COLORS:

Black/White/Race yellow

SIZES:

XS – XXL



RACING RAIN COAT

ART.N°: 829373

FEATURES:

- 2 side pockets
- Chest pocket
- 10.000 mm water column
- 10.000g/m²/24 h breathability

COLORS:

Black/White/Race yellow

SIZES:

XS – XXL



RACING SOFTSHELL SHORTS

ART.N°: 829353

FEATURES:

- Protective pads
- 10.000 mm water column
- 10.000g/m²/24 h breathability

COLORS:

Black/White/Race yellow

SIZES:

XS – XXL

RACING SUIT

ART.N°: 829363

FEATURES:

- Full side zip
- Waist adjustment
- Detachable suspenders
- 2 side pockets
- 10.000 mm water column
- 10.000g/m²/24 h breathability

COLORS:

Black/White/Race yellow

SIZES:

XS – XXL



BAGS

REBELS TRAVELBAG

ART.N°: 383503

FEATURES:

- Big wheelie bag for ski pros and world travellers
- Long stowable pull handle for easy carrying
- Big zippered compartment in top part
- Two big zipper compartments in lower part

- Large additional compartment at the top
- Special base fabric
- Padded heavy-duty casing
- Neon lining

DIMENSIONS:

84x34x40 cm

VOLUME:

96l



REBELS RACING BACKPACK

ART.N°: 383633

FEATURES:

- Big backpack for racers coaches and tech-reps
- Anatomically designed back padding with fully adjustable padded dorsal strap system
- Mesh pocket on the front
- Water and dirt repellent bottom fabric

- Water bottle pocket
- PP lining

DIMENSIONS:

40x59x28 cm

VOLUME:

70l



REBELS SKIBAG – 4 PAIRS

ART.N°: 383513

FEATURES:

- Protective bag for 4 pairs of skis
- High quality wheels for carrying comfort
- Divider inside the bag
- Two compressions straps
- PP lining

DIMENSIONS:

200x44x20 cm

VOLUME:

142l



REBELS DOUBLE SKIBAG

ART.N°: 383523

FEATURES:

- Protective bag for 2 pairs of skis
- Two wheels for carrying comfort
- Water and dirt repellent bottom fabric
- Padded main compartment with two buckles

- Easy-to-adjust compression straps
- Neon lining

DIMENSIONS:

195x18x28 cm

VOLUME:

103l



HEATABLE BOOT BAG

ART.N°: 383542

FEATURES:

- Heatable boot backpack
- Comfortable handles and stowable padded backpack straps
- Padded goggle compartment
- Various small zippered pockets for socks, bottles, gloves, clothing...
- Adjustable helmet holder
- Four way controller switch with house (110/V or 220/V) DC plug in

- Automotive cable plug in (12/V) AC
- Three temperature settings:
Hot (70°C/150°F)
Dry (60°C/130°F)
Warm (50°C/122°F)

DIMENSIONS:

25x43x38 cm

VOLUME:

40l





PERFORMANCE

**WHEN YOU LIVE LIFE TO
THE FULLEST SPEED.
WHEN SLOWING DOWN IS
A WASTE OF TIME. WHEN
YOU'RE READY TO TAKE
DEEP CUTS FOR A BETTER
EDGE.
WHAT'S YOUR LIMIT?**

When the cage called summer is opened and the heat has finally passed, the skier is released to the mountain on cold turkey. In a state of limitless rush and stampede, he feeds his soul on Speed, his spirit on freedom, his ego on altitude.

**ONCE AGAIN, WE ARE ON TOP OF THE WORLD – READY TO EMBRACE
IT AND RACE IT.**

SKI TECHNOLOGY | ERA 3.0 S

PERFORMANCE

ERA 3.0 S

THE SUPERSHAPE LINE WAS CALLED THE SUPERSHAPE BECAUSE FROM ITS INCEPTION IT WAS SHAPED TO PERFECTION. NOW, THE SUPERSHAPE HAS TAKEN ON ERA 3.0 S.

It's the sports version with a multi-faceted ski designed with race innovation and inspiration, yet now with the addition of Rocker, Radius and Rebound. With a totally unique

V-Shape construction this is not just a new ski, it is a totally new skiing experience. The new Supershape with ERA 3.0 S is the combination of all mountain carving, race technology,

and a new gradient on turning mechanics and ski capabilities sure to impress skiers on many levels. 10% Rocker and 90% camber are combined to impress. The additional layer

of Intellifibers provides explosive power, control and increased responsiveness.

BINDING TECHNOLOGY | PRD & PRX POWERRAIL

POWERRAIL TECHNOLOGY

THE PERFORMANCE BINDING THAT MEETS THE DEMANDS OF AMBITIONED SKIERS. WELCOME TO THE FAST LANE IN BINDING TECHNOLOGY EVOLUTION.

- Easy Mounting & Adjusting
- Modular System
- Ideal for Retail, Demo and Rental
- Maximum Flexibility

FEATURES

NO DRILLING OR SCREWING. JUST SLIDING.

- [1] Open toe lever and adjust.
- [2] Do the same with the heel.
- [3] Close the toe and heel lever. Done.



MODULAR SYSTEM

The PowerRail System was built modularly to match any rider's needs. Covering all segments with choices of Standard or Pro bases and dampeners in different widths for perfect ski fitting. PowerRail suits sole lengths between 260mm and 380mm.

DOUBLE THE FLEX

The PowerRail Pro base is equipped with an additional freeflex band, linking the toothed areas at the toe and heel side of the base, allowing toe and heel pieces to glide unhindered. The double freeflex function ensures even more freedom, safety, and performance.

NATURAL FLEX

To ensure unhindered natural flex the PowerRail base is mounted with one pair of fixed screws and three pairs of free gliding screws. This way the base smoothly adapts to the flex of the ski.

LONG-TERM PERFORMANCE

Each toe and heel guide can be exchanged or fitted separately, ensuring full functionality even after massive rental use.

BETTER POWER TRANSMISSION

PowerRail bases are 7% wider and 25% lower than Railflex II bases, directly improving power transmission from boot to edge.



i.SUPERSHAPE TITAN

ART.N°: 310083

FEATURES:



- KERS
- ERA 3.0 S
- Race structured UHM C base
- WC sandwich construction

LENGTHS:

156/163/170/177

DIMENSIONS:

133/80/111 @ length 170

RADIUS:

14,3 @ length 170

SKILLS:

Level III Speed III

PLATES:

PowerRail Pro

BINDINGS:

ART.N°: 100514 PRD 14 S wide 88



i.SUPERSHAPE RALLY

ART.N°: 310183

FEATURES:



- KERS
- ERA 3.0 S
- Race structured UHM C base
- WC sandwich construction

LENGTHS:

149/156/163/170/177

DIMENSIONS:

131/76/109 @ length 170

RADIUS:

13,6 @ length 170

SKILLS:

Level III Speed III

PLATES:

PowerRail Pro

BINDINGS:

ART.N°: 100522 PRX 12 S



i.SUPERSHAPE MAGNUM

ART.N°: 310123

FEATURES:



- KERS
- ERA 3.0 S
- Race structured UHM C base
- WC sandwich construction

LENGTHS:

149/156/163/170/177

DIMENSIONS:

128/72/106 @ length 170

RADIUS:

13,1 @ length 170

SKILLS:

Level III Speed III

PLATES:

PowerRail Pro

BINDINGS:

ART.N°: 100522 PRX 12 S



i.SUPERSHAPE SPEED

ART.N°: 310153

FEATURES:



- KERS
- ERA 3.0 S
- Race structured UHM C base
- WC sandwich construction

LENGTHS:

156/163/170/177/184

DIMENSIONS:

119/66/98 @ length 170

RADIUS:

14,3 @ length 170

SKILLS:

Level III Speed III

PLATES:

PowerRail Pro

BINDINGS:

ART.N°: 100522 PRX 12 S

SKI TECHNOLOGY I INTELLIGENCE TECHNOLOGY

ELECTRONIC SKI MANAGEMENT SYSTEM

HEAD's theory of relativity: Ski performance is not an absolute measure. What you want out of a ski always depends on how and where you ride. On hard-packed slopes you want perfect edge grip. On soft snow, you want more maneuverability. Breaking the slope record you want your ski to perform differently than when you're just cruising with your friends or family. Adaptive HEAD Intelligence™ Technology helps your ski perform perfectly – both relative to terrain and your individual riding mode.

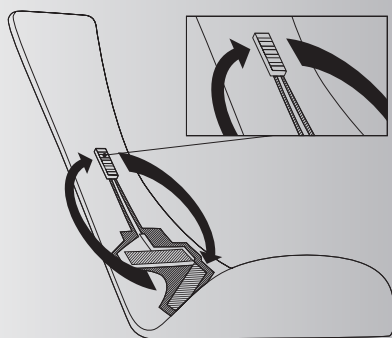

HOW IT WORKS

Intellifibers positioned at 45° in front of the binding transform mechanical impulses into electrical energy. The harder you ride, the more energy is produced. The electrical energy is led back to the Intellifibers. This causes them to stiffen up, putting more rebound and torsional stiffness into the ski.

WHAT IT DOES

Their 45° position in front of the binding increases the ski's torsional stiffness, pushing the edge into the snow in hard turns. Intelligence™ progressively stabilizes the entire ski at high speeds.



THE EXTRA BOOST

Some HEAD high-end skis boast **Intelligence™ Chip Technology**. Here, the electrical energy produced by the Intellifibers is not just recycled, but accumulated and released bit by bit through a pre-programmed chip – individually timed to match the oscillation properties of the ski. Thus, the effect of Intelligence™ is multiplied, providing even more performance relative to your skiing style.



PRESTIGE

ART.N°: 310323

FEATURES:



- ERA 3.0 S
- Intelligence™ Chip Technology
- WC sandwich construction
- Metal Power Tubes
- Race structured UHM C base

LENGTHS:

149/156/163/170/177

DIMENSIONS:

131/76/109 @ length 170

RADIUS:

13,6 @ length 170

SKILLS:

Level ■■■ Speed ■■■

PLATES:

PowerRail Pro

BINDINGS:

ART.N°: 100515 PRD 14



LIMITED

ART.N°: 310303

FEATURES:



- ERA 3.0 S
- Intelligence™ Chip Technology
- WC sandwich construction
- Metal Power Tubes
- Race structured UHM C base

LENGTHS:

149/156/163/170/177

DIMENSIONS:

128/72/106 @ length 170

RADIUS:

13,1 @ length 170

SKILLS:

Level ■■■ Speed ■■■

PLATES:

PowerRail Pro

BINDINGS:

ART.N°: 100515 PRD 14

BOOT TECHNOLOGY | PERFECT FIT

PERFORMANCE



Venture 130



Challenger 130



Vector 125



PERFECT FIT

Perfect Fit is the revolutionary customization system that provides the best level of precision, comfort and durability.

1. 100% full customization.

The new innerboot perfectly adapts to the foot and the shell.

2. Increased precision, performance and comfort durability.

3. Customization can be repeated virtually without limitation.

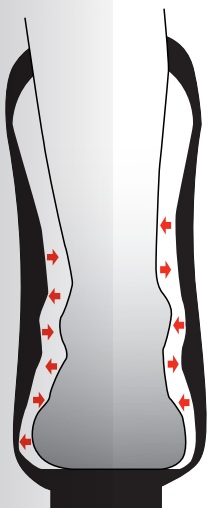

OVEN

1. Warm up shell and liner for 5 minutes at 80°C.
2. Step in and close the buckles.
3. In 10 minutes the customization is ready.





BOOT TECHNOLOGY | CHALLENGER

PERFORMANCE

NEW DOUBLE POWER SPINEFLEX BUCKLES

Spineflex is a revolutionary buckle concept with a flexible element and a constant closure point. The flexible element allows the buckle to adapt to the shell profile and thus provide

a homogeneous foot wrapping independent from the degree of closure. The increased precision and comfort created from the absence of pressure points results in better performance.

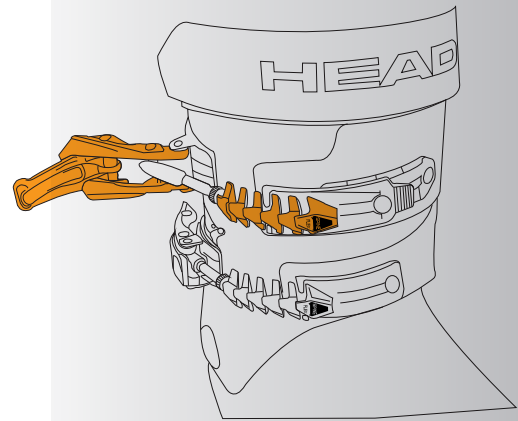

ADAPTIVE FIT TECHNOLOGY

Adaptive Fit Technology is the first and only ski boot technology that lets you change the width of your boot from a 104mm comfort/performance last to a 102mm precision/performance last with the turn of a screw.

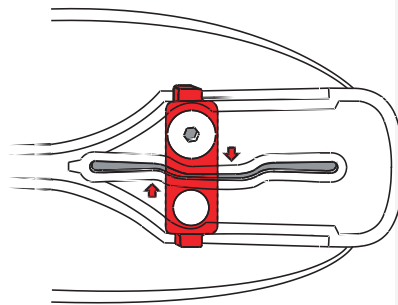

POWER SKI HIKE

Provides the easiest selection of ski and hike mode available. Easy to identify and operate, yet providing a powerful connection between the cuff and shell for maximum precision and impulse transmission.

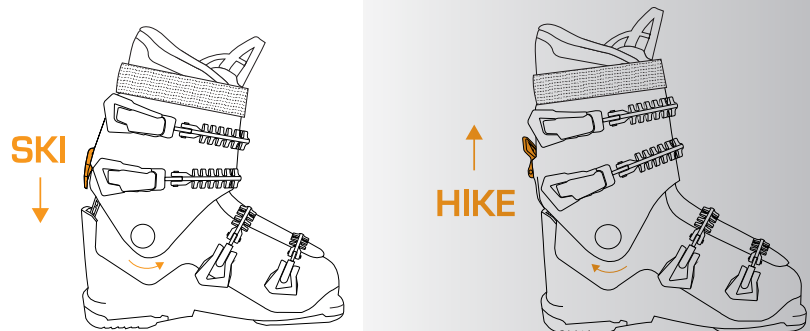

3 STEPS TO PERFECT FIT

In combination with the Adaptive Fit Technology available on the new Challenger line it defines the new state of the art in the high performance skiboots category.



BOOTS

CHALLENGER 130

ART.N°: 603025

**LINER:**

- Perfect Fit HP Pro liner
- HP frame footbed
- 40mm velcro strap

BUCKLES:

- 4 micro-adjustable Spineflex alloy buckles
- 2 Double Power levers
- 1 supermacro ratchet

FEATURES:

- Bi-Inj. frame
- Adaptive Fit Technology
- Ski-Hike mechanism
- Easy Entry shell design
- Flex stance tuning
- Double canting
- Rear support tuning

LEVEL:

Professional

FLEX INDEX:

130

SIZES:

240 – 250 – ... – 305

SHELL:

PU

LAST:

S 2000cc

LAST	97-99	99-101	101-103
SIZE	25.5	26.5	27.5

COLOR:

Trsp. Red/White/Black



CHALLENGER 120

ART.N°: 603028

**LINER:**

- Perfect Fit HP liner
- HP frame footbed
- 40mm velcro strap

BUCKLES:

- 4 micro-adjustable Spine-Tech alloy buckles
- 2 Double Power levers
- 1 supermacro ratchet

FEATURES:

- Bi-Inj. frame
- Adaptive Fit Technology
- Ski-Hike mechanism
- Easy Entry shell design
- Flex stance tuning
- Double canting
- Rear support tuning

LEVEL:

Professional

FLEX INDEX:

120

SIZES:

250 – 255 – ... – 305

SHELL:

PU

LAST:

S 2000cc

LAST	97-99	99-101	101-103
SIZE	25.5	26.5	27.5

COLOR:

Trsp. Green/White

CHALLENGER 110

ART.N°: 603032

**LINER:**

- Perfect Fit S liner
- HP frame footbed
- 40mm velcro strap

BUCKLES:

- 4 micro-adjustable Spine-Tech alloy buckles
- 1 supermacro ratchet

FEATURES:

- Bi-Inj. frame
- Adaptive Fit Technology
- Ski-Hike mechanism
- Easy Entry shell design
- Flex tuning
- Double canting
- Rear support tuning

LEVEL:

Expert

FLEX INDEX:

110

SIZES:

240 – 250 – 255 – ... – 305

SHELL:

PU/SL

LAST:

S 2000cc

LAST	97-99	99-101	101-103
SIZE	25.5	26.5	27.5

COLOR:

Trsp. Anthracite/Black



BOOTS

VECTOR 125

ART.N°: 603040



LINER:

- Perfect Fit HP liner
- HP frame footbed
- 40mm velcro strap

BUCKLES:

- 4 micro-adjustable Spineflex alloy buckles
- 2 Double Power levers
- 1 supermacro ratchet

FEATURES:

- Tri-Inj. frame
- Easy Entry shell design
- Flex stance tuning
- Double canting
- Rear support tuning

LEVEL:

Professional

FLEX INDEX:

125/115

SIZES:

250 – 255 – ... – 305

SHELL:

PU

LAST:

S 2000cc

LAST	99	101	103
SIZE	25.5	26.5	27.5

COLOR:

Black/Trsp. Black



VECTOR 115

ART.N°: 603045

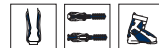

LINER:

- Perfect Fit HP liner
- HP frame footbed
- 40mm velcro strap

BUCKLES:

- 4 micro-adjustable Spine-Tech alloy buckles
- 2 Double Power levers
- 1 supermacro ratchet

FEATURES:

- Tri-Inj. frame
- Easy Entry shell design
- Flex stance tuning
- Double canting
- Rear support tuning

LEVEL:

Expert

FLEX INDEX:

115/105

SIZES:

250 – 255 – ... – 305

SHELL:

PU

LAST:

S 2000cc

LAST	99	101	103
SIZE	25.5	26.5	27.5

COLOR:

White/Trsp. Green/Black

VECTOR 105

ART.N°: 603055



LINER:

- Perfect Fit S liner
- HP frame footbed
- 40mm velcro strap

BUCKLES:

- 4 micro-adjustable Spine-Tech alloy buckles
- 1 supermacro ratchet

FEATURES:

- Tri-Inj. frame
- Easy Entry shell design
- Flex tuning
- Double canting
- Rear support tuning

LEVEL:

Expert

FLEX INDEX:

105/95

SIZES:

250 – 255 – ... – 305

SHELL:

PU/SL

LAST:

S 2000cc

LAST	99	101	103
SIZE	25.5	26.5	27.5

COLOR:

White/Trsp. Red/Black



POLES



SUPERSHAPE VIP

ART.N°: 381133

COLOR:

Black/White/Yellow

DIAMETER Ø:

16 mm AIR FOIL

LENGTHS:

110 – 135 cm

FEATURES:

- Air Foil profile
- 7075 Aluminum
- Positive angle safety thermo grip with chrome finish
- Carbide tip
- 50 mm race basket yellow

CARBON PRESTIGE

ART.N°: 381043

COLOR:

Carbon black/White/Yellow

DIAMETER Ø:

11 mm

LENGTHS:

105 – 135 cm

FEATURES:

- Positive angle safety thermo grip with chrome finish
- Lock security strap
- Carbide flex tip alpine
- Vision race basket 50 mm



HEAD CLASSIC

ART.N°: 381993

COLOR:

Silver/Black

DIAMETER Ø:

16 mm

LENGTHS:

105 – 135 cm

FEATURES:

- 7075 Aluminum brushed
- Positive angle safety bi-injected soft grip
- Lock security strap
- Alpine race basket 50 mm
- Ice steel tip

HELMET TECHNOLOGY | RUNTASTIC

PERFORMANCE



HEAD and runtastic teamed up to build the world's first fully integrated runtastic product in winter sports.



HEAD SENSOR BT RUNTASTIC



HEAD's safety award-winning SENSOR helmet is an all-rounder for every terrain. Its safety, comfort and clever features characterize the helmet. RUNTASTIC, one of the most popular fitness apps for smart phones, adds yet another feature to the helmet. The outcome is the most innovative, emotional, safe, and fun helmet for the upcoming winter season.

runtastic fitness app key features:

- Listen to music
 - Live tracking (friends can follow you)
 - Cheering from friends
 - Voice Coach
 - Distance
 - Duration
 - Speed
 - Pace
 - Heart Rate Zones
 - Calories
 - Elevation gain/loss
 - Interval training
 - All data is tracked & saved
 - and more ...
- Languages:
- 18 languages (app)
 - 10 languages (web)

Connect the runtastic Heart Rate Monitor* with your:

- + smartphone
- + cardio equipment
- + runtastic equipment

* Works with iPhone 4S, iPhone 5. More devices: www.runtastic.com/en/products

head.com runtastic.com

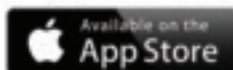

Package content:
Helmet Head Sensor BT runtastic
BTLE Chest Strap
runtastic app

HELMETS

SENSOR BT RUNTASTIC

HEAD SENSOR, the base model for HEAD's SENSOR BT RUNTASTIC, is the awarded winner of the German ADAC helmet test. The in-mold construction makes this helmet a light-weight, which is packed with unique features to make it as comfortable as safe. The ear pads with integrated speakers are height adjustable and the built-in microphone is bendable for your comfort. The integrated Bluetooth module connects with your smart phone to output all the valuable information of the app straight to your ears and enables other options, like taking phone calls for example. This makes the SENSOR BT RUNTASTIC the most innovative and fully technical integrated winter sports helmet on the market.

ART.N°: 324013

FEATURES:

- BT System with microphone and audio earpads
- Adjustable ventilation
- Height adjustable earpads
- Twist stop goggle retainer
- 2D-Fit system
- Integrated liner windshield

SIZES AND WEIGHTS:

XS/S	M/L	XL/XXL
450g	470g	500g



HELMET TECHNOLOGY | CONEHEAD

CONEHEAD TECHNOLOGY IN ACTION:

In a crash, the impact force pushing towards the head causes the higher density outer layer to compress. At the same time, the head is travelling in the opposite direction, compressing the lower density inner layer and the tops of the cones of the higher density outer layer. Therefore the energy is spread sideways within the foam

instead of towards the head. The increasing resistance of the collapsing cones allows the head to gradually slow down.

THE RESULT is a lower g-force experience for your head.

THE BENEFITS: A lighter helmet + softer protective shock absorbing foam closer to your head.

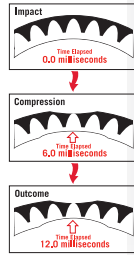

CREST

High-tech for all-mountain use. The CREST offers outstanding impact protection, thanks to its HYBRID SHELL and CONEHEAD SANDWICH CORE. The adjustable 2-zone ventilation, the 3D FIT SYSTEM and the patented height-adaptable earpieces ensure maximum possible comfort and customisability.

FEATURES:

- Durable and lightweight hybrid shell construction
- Perfect shock absorption with CONEHEAD SANDWICH CORE
- Adjustable dual zone ventilation
- Height adjustable earpads
- Twist stop goggle retainer
- 3D-Fit System
- Integrated liner windshield
- Removable brim

SIZES AND WEIGHTS:

XS/S	M/L	XL/XXL
495 g	540 g	580 g

COLORS:

Black	ART.N°: 324113
Blue/Yellow	ART.N°: 324123



Black



Blue/
Yellow



SENSOR

The ADAC test-winning helmet, in a new design. The revised shape gives the SENSOR a more dynamic appearance, the colours and materials are timeless and elegant. The list of features is headed by adjustable ventilation, a size adjustment system and height-adaptable earpieces.

FEATURES:

- Adjustable ventilation
- Height adjustable earpads
- Twist stop goggle retainer
- 2D-Fit System
- Integrated liner windshield

SIZES AND WEIGHTS:

XS/S	M/L	XL/XXL
375 g	395 g	425 g

COLORS:

Black	ART.N°: 324212
Anthracite	ART.N°: 324223



Black



Anthracite



GOGGLES

STIVOT

The STIVOT GOGGLE has the perfect shape and design for our Performance and Allride helmets. The spherical polycarbonate double lens provides maximum visibility and UV 400 protection. The silicone-coated straps ensure a non-slip grip on the helmet.

FEATURES:

- Sprayed polycarbonate lens for maximum safety
- UV 400 protection & anti-fog double lens
- Triple-layer foam
- Silicone layer
- Compatible with HEAD helmets
- Inclusive spare lens

COLORS:

Black ART.N°: 373113
White ART.N°: 373123



Black



White

PROTECTION

FLEXOR VEST

The FLEXOR VEST offers not just a soft protector that fits your back perfectly, but also a high-quality 4-way-stretch thermo fleece, an extra-wide waist belt and permanent anti-bacterial functionality through the use of POLYGIENE.

ART.N°: 395213

FEATURES:

- Perfectly dampening and highly energy absorbing with SAS TEC viscoelastic foam
- Antibacterial and odor-freeness life guarentee with Polygiene 
- Removable protection unit
- 4-way stretch fleece material

SIZES:

S – XXL



Front



Back



ALLRIDE

**WHEN IDEAS ARE THE ONLY
THING YOU FOLLOW. WHEN
ALL TYPES OF TERRAIN
FEEL LIKE YOUR HOME TURF.
WHEN YOU LOOK BEYOND
HORIZONS AND THEN GO
SKI THERE.
WHAT'S YOUR LIMIT?**

There are individuals who defy categorization. People who live and think out of the box simply because they deny the boxes' existence. Free spirits who cross boundaries of convention without even realizing them. Characters whose answer to *what?* is whatever. To *where?* is wherever. And to *what for?* is forever.

**WE LIVE IN THE MOMENT. IN THE TERRAIN. AND WHILE WE MAKE
THE BEST OUT OF WHAT WE SEE, WE'RE HAPPY WITH EVERYTHING
WE'VE GOT.**

ERA 3.0 – ROCKER DONE RIGHT

IMAGINE A SKI THAT PERFORMS FOR EVERYONE, ANYWHERE: ONE FOR ALL. ALL IN ONE. HEAD ERA 3.0 IS NOT YOUR ONE-DIMENSIONAL «HAVE A PROBLEM? WE FIX IT!» TECHNOLOGY. ERA 3.0 IS A COMBINATION OF TECHNOLOGIES, SHAPE AND GEOMETRY. THINK ROCKER, THINK RADIUS, THINK REBOUND. THINK 3-DIMENSIONAL.

⊕ EFFORTLESS STEERING

⊕ SOFT SNOW VERSATILITY

20% ROCKER, 80% CAMBER

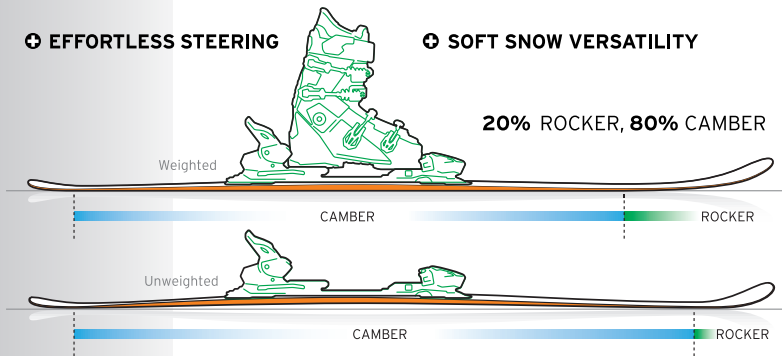

1 | ALLRIDE ROCKER

FOR SUPERIOR STEERING AND INCREASED FLOATATION.

We place a highly targeted amount of rocker in each model to ensure maximum performance for all ability levels. Steering is easier for all skiers and soft snow versatility is enhanced.

⊕ INSTANT GRIP

⊕ EFFORTLESS TURNING

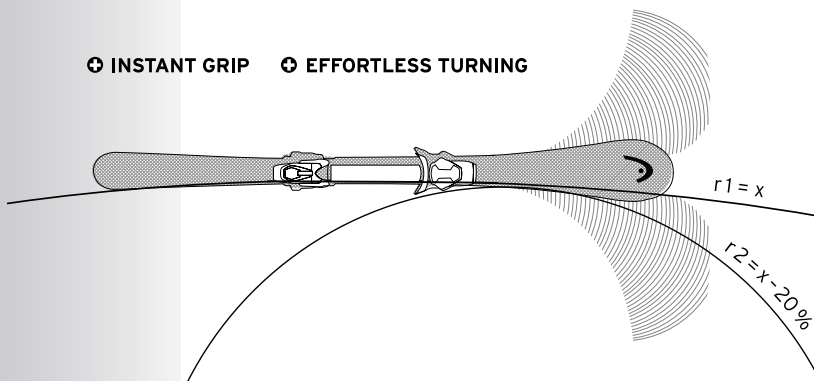

2 | PROGRESSIVE RADIUS

FOR TREMENDOUS TURNING.

Regular rocker makes skiers place their ski further on edge to have it touch from tip-to-tail. With progressive radius, up to 50% less angulation is needed to enjoy full edge contact. MORE EDGE ON THE SNOW = MORE EDGE GRIP.

⊕ MORE STABILITY

⊕ REDUCED VIBRATIONS

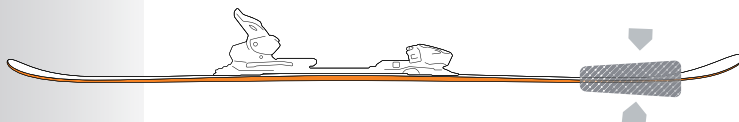

3 | INTELLIRISE REBOUND

FOR TARGETED STABILITY.

We move our legendary piezoelectric Intellifibers to the tip of the ski. The nasty tip vibrations found on regular rockers are not found here. These skis are too smart for that.



REV 105

ART.N°: 310433

FEATURES:



- ERA 3.0
- Sandwich cap construction
- Structured UHM C base

LENGTHS:

171/181/191

DIMENSIONS:

144/105/131 @ length 181

RADIUS:

16,0 @ length 181

SKILLS:

Level ■■■ Speed ■■■

BINDINGS:

ART.N°: 111617 AAAttack 13



REV 90

ART.N°: 310433

FEATURES:



- ERA 3.0
- Sandwich cap construction
- Structured UHM C base

LENGTHS:

149/156/163/170/177/184

DIMENSIONS:

136/91/117 @ length 177

RADIUS:

16,6 @ length 177

SKILLS:

Level ■■■ Speed ■■■

BINDINGS:

ART.N°: 111616 AAAttack 13 wide 97



REV 85 PRO

ART.N°: 310423

FEATURES:



- ERA 3.0
- Sandwich cap construction
- Structured UHM C base
- Also available without PowerRail (Art.N°: 310413)

LENGTHS:

163/170/177/184

DIMENSIONS:

132/86/114 @ length 177

RADIUS:

15,9 @ length 177

SKILLS:

Level ■■■ Speed ■■■

PLATES:

PowerRail

BINDINGS:

ART.N°: 100521 PRD 12 wide 88



REV 80 PRO

ART.N°: 310463

FEATURES:



- ERA 3.0
- Sandwich cap construction
- Structured UHM C base

LENGTHS:

156/163/170/177/184

DIMENSIONS:

130/81/112 @ length 177

RADIUS:

14,8 @ length 177

SKILLS:

Level ■■■ Speed ■■■

PLATES:

PowerRail

BINDINGS:

ART.N°: 100526 PR 11 wide 90



REV 78

ART.N°: 310563

FEATURES:

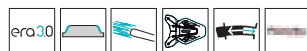

- ERA 3.0
- Power sidewall jacket
- Structured UHM C base

LENGTHS:

142/149/156/163/170/177

DIMENSIONS:

127/78/110 @ length 170

RADIUS:

13,6 @ length 170

SKILLS:

Level ■■■ Speed ■■■

PLATES:

PowerRail

BINDINGS:

ART.N°: 100527 PR 11



REV 75

ART.N°: 310503

FEATURES:



- ERA 3.0
- Full carbon jacket
- Structured UHM C base

LENGTHS:

149/156/163/170/177

DIMENSIONS:

125/75/109 @ length 170

RADIUS:

13,5 @ length 170

SKILLS:

Level ■■■ Speed ■■■

PLATES:

PowerRail

BINDINGS:

ART.N°: 100527 PR 11



INTEGRALE 009

ART.N°: 310233

FEATURES:



- ERA 3.0
- Sandwich cap construction
- Race structured UHM C base
- Diffusor

LENGTHS:

149/156/163/170/177

DIMENSIONS:

127/75/111 @ length 170

RADIUS:

13,2 @ length 170

SKILLS:

Level III Speed III

PLATES:

PowerRail

BINDINGS:

ART.N°: 100528 PR 11



INTEGRALE 007

ART.N°: 310243

FEATURES:



- ERA 3.0
- Sandwich cap construction
- Race structured UHM C base
- Diffusor

LENGTHS:

149/156/163/170/177

DIMENSIONS:

125/72/109 @ length 170

RADIUS:

12,9 @ length 170

SKILLS:

Level III Speed III

PLATES:

PowerRail

BINDINGS:

ART.N°: 100527 PR 11



INTEGRALE 005

ART.N°: 310253

FEATURES:



- ERA 3.0
- Power carbon jacket
- Structured UHM C base
- Diffusor

LENGTHS:

149/156/163/170/177

DIMENSIONS:

125/70/109 @ length 170

RADIUS:

12,5 @ length 170

SKILLS:

Level III Speed III

PLATES:

PowerRail

BINDINGS:

ART.N°: 100528 PR 11

BOOT TECHNOLOGY | EDGE

EDGE TECHNOLOGY

THE HEAD EDGE REMAINS THE MOST VERSATILE, ADAPTIVE BOOT ON THE MARKET. WITH ADAPTIVE FIT TECHNOLOGY, A TRI(BI)-INJECTION FRAME, EASY ENTRY SHELL DESIGN AND SPINE-TECH DOUBLE POWER BUCKLES, THE EDGE IS ON THE CUTTING EDGE OF PERFORMANCE AND COMFORT.

ADAPTIVE FIT TECHNOLOGY

Adaptive Fit Technology is the first and only ski boot technology that lets you change the width of your boot from a 104 mm comfort/performance last to a 102 mm precision/performance last with the turn of a screw.

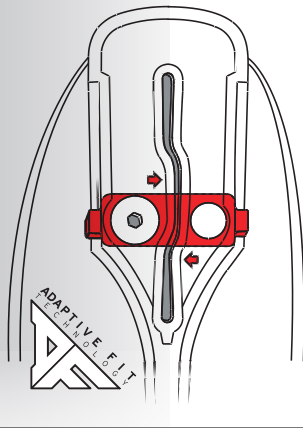

TRI (BI)-INJECTION FRAME

A high performance, multi-density shell that optimizes easy entry, foot wrapping, comfort and energy transmission.



DOUBLE POWER SPINE-TECH BUCKLES

Spine-Tech buckles provide constant traction and avoid pressure points, improving both comfort and precision. The ergonomic, patented Double Power lever increases the leverage of the buckle by 50%, halving the effort required to buckle in constant release values.

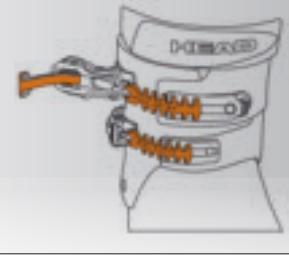

BOOTS

ADAPTEGE 100



LINER:

- HP HeatFit liner
- Sport frame footbed
- 40mm velcro strap

BUCKLES:

- 4 micro-adjustable Spine-Tech alloy buckles
- 2 Double Power levers
- 1 supermacro ratchet

FEATURES:

- Tri-Inj. energy frame
- Adaptive Fit Technology
- Easy Entry shell design
- Stiffer/softer flex adjustment
- Double canting
- Adjustable rear spoiler
- SoftWalk heel + grip system

LEVEL:

Advanced

FLEX INDEX:

100/90

SIZES:

250 – 260 – 265 – ... – 340

SHELL:

PU/SL

LAST:

C 2100cc

LAST	100-98	102-100	104-102
SIZE	25.5	26.5	27.5

COLORS:

Trsp. Red/White
Trsp. Blue/White

ART.N°: 603109
ART.N°: 603112



BOOTS

ADAPTEGE 90



LINER:

- HeatFit liner
- Sport frame footbed
- 40mm velcro strap

BUCKLES:

- 4 micro-adjustable alloy buckles
- 2 Double Power levers
- 1 supermacro ratchet

FEATURES:

- Tri-Inj. energy frame
- Adaptive Fit Technology
- Easy Entry shell design
- Stiffer/softer flex adjustment
- Double canting
- Adjustable rear spoiler
- SoftWalk heel + grip system

LEVEL:

Advanced

FLEX INDEX:

90/80

SIZES:

250 – 260 – 265 – ... – 305

SHELL:

SL

LAST:

C 2100cc

LAST	100-98	102-100	104-102
SIZE	25.5	26.5	27.5

COLORS:

Trsp./Black/Red **ART.N°: 603143**
 Trsp./Black/Yellow **ART.N°: 603142**



ALRLIDE



NEXTEDGE 80

ART.N°: 603170



LINER:

- HeatFit liner
- Sport frame footbed
- 40mm velcro strap

BUCKLES:

- 4 micro-adjustable alloy buckles
- 1 supermacro ratchet

FEATURES:

- Tri-Inj. energy frame
- Easy Entry shell design
- Double canting
- SoftWalk heel

LEVEL:

Advanced

FLEX INDEX:

80

SIZES:

250 – 260 – 265 – ... – 305

SHELL:

SL

LAST:

C 2100cc

LAST	100	102	104
SIZE	25.5	26.5	27.5

COLOR:

Black/White



NEXTEDGE 70



LINER:

- Comfort liner
- Sport frame footbed
- 40mm velcro strap

BUCKLES:

- 4 micro-adjustable plastic buckles
- 1 supermacro ratchet

FEATURES:

- Tri-Inj. energy frame
- Easy Entry shell design
- Double canting
- SoftWalk heel

LEVEL:

Intermediate

FLEX INDEX:

70

SIZES:

250 – 260 – 265 – ... – 305

SHELL:

SL

LAST:

C 2100cc

LAST	100	102	104
SIZE	25.5	26.5	27.5

COLORS:

White/Black **ART.N°: 603233**
 Black/Anthracite **ART.N°: 603232**

BOOT TECHNOLOGY | CUBE3

EASY AS 1, 2, 3.

DEVELOPING OUR CUBE3 LINE, WE DECIDED TO TACKLE THE ONE CHALLENGE EVERY SKIER FACES EVERY DAY ON THE MOUNTAIN: TO COMBINE GREAT SKIING PERFORMANCE WITH GREAT WALKING PERFORMANCE. AFTER ALL, ON ANY GIVEN DAY, WE SPEND UP TO 30% OF OUR TIME OUTSIDE OF THE BINDING.

EASY IN

Thanks to a new quick entry geometry, the Cube3 is extremely easy to get into. Simply tilt back the shaft and step in. In addition, the 3-buckle construction with an oversized top buckle allows easy and quick buckling in and a great, snug fit.

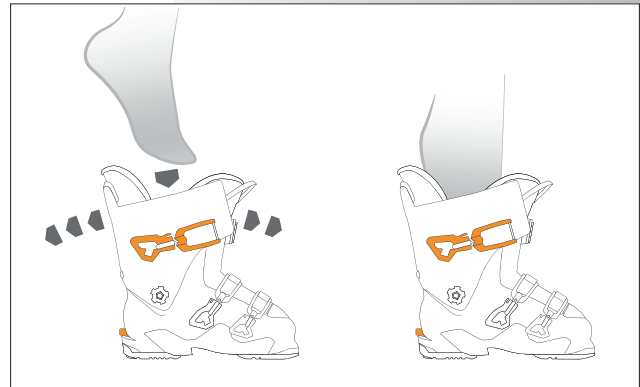

EASY WALK

Outside of the binding, the shaft of the Cube3 is always unlocked, allowing natural walking.

This, in combination with (patented) SoftWalk heel and grip system on the heel, makes the Cube3 a superb walking boot.

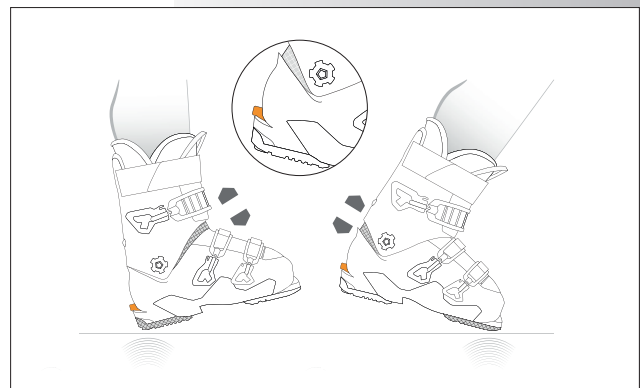

EASY SKI

The moment you step into your binding the patented integrated AutoSkiWalk mechanism blocks the shaft, allowing you to speed off down the mountain without bowing, bending or buckling.

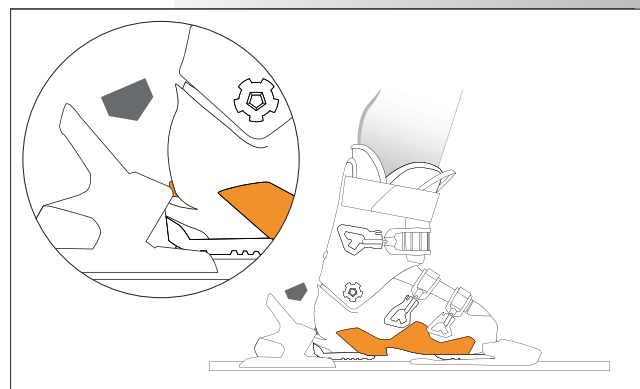

BOOTS

CUBE3 12

ART.N°: 603320



LINER:

- SuperHeat3 quick entry liner
- Sport frame footbed
- 35 mm velcro strap

BUCKLES:

- 2 micro-adjustable alloy buckles
- 1 micro-adjustable wide-body alloy buckle
- 1 supermacro ratchet

FEATURES:

- Bi-Inj power control frame
- Integrated AutoSkiWalk
- SoftWalk heel + grip system

LEVEL:

Advanced

FLEX INDEX:

90

SIZES:

250 – 260 – 265 – ... – 305

SHELL:

PU/SL

LAST:

EC 2200cc

LAST	102	104	106
SIZE	25.5	26.5	27.5

COLOR:

Trsp. Red/White



CUBE3 10

ART.N°: 603331



LINER:

- HeatFit quick entry liner
- Sport frame footbed
- 35 mm velcro strap

BUCKLES:

- 2 micro-adjustable alloy buckles
- 1 micro-adjustable wide-body alloy buckle
- 1 supermacro ratchet

FEATURES:

- Bi-Inj power control frame
- Integrated AutoSkiWalk
- SoftWalk heel + grip system

LEVEL:

Intermediate

FLEX INDEX:

80

SIZES:

250 – 260 – 265 – ... – 305

SHELL:

SL

LAST:

EC 2200cc

LAST	102	104	106
SIZE	25.5	26.5	27.5

COLOR:

Trsp./Black

CUBE3 8

ART.N°: 603382



LINER:

- Comfort quick entry liner
- Sport frame footbed
- 35 mm velcro strap

BUCKLES:

- 2 micro-adjustable alloy buckles
- 1 micro-adjustable wide-body alloy buckle
- 1 supermacro ratchet

FEATURES:

- Power control frame
- Integrated AutoSkiWalk

LEVEL:

Intermediate

FLEX INDEX:

70

SIZES:

250 – 260 – 265 – ... – 320

SHELL:

SL

LAST:

EC 2200cc

LAST	102	104	106
SIZE	25.5	26.5	27.5

COLOR:

Black



POLES



MULTI S

COLORS:

Black/Orange **ART.N°: 381113**
 Black/Silver **ART.N°: 381123**

DIAMETER Ø:

18mm

LENGTHS:

105 – 135cm

FEATURES:

- Glossy matt finish
- Bi-injected grip
- Automatic strap
- 5083 Aluminum
- Race basket
- Star tip



MULTI

COLORS:

Silver/Black **ART.N°: 381813**
 White/Red **ART.N°: 381823**
 White/Blue **ART.N°: 381833**

DIAMETER Ø:

18mm

LENGTHS:

105 – 135cm

FEATURES:

- Ergo PE grip
- Automatic strap
- 5086 Aluminum
- Race basket
- Star tip

HELMET TECHNOLOGY | RESPIRO CORE

RESPIRO CORE

Our new RESPIRO core is used in the helmets of the STIVOT and VENTOR series. This EPS foam core is perforated throughout and this construction ensures a pleasantly ventilated micro-climate inside the helmet, coupled with a low weight.

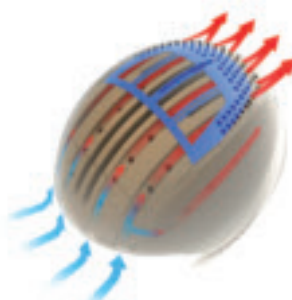

HELMETS

STIVOT AIR

The models in the STIVOT AIR range have inherited the legacy of our racing helmet. The half-shell design with soft earpieces, adjustable ventilation and an additional size adjustment system make this helmet an ideal protection for sports-minded skiers and snowboarders.

FEATURES:

- Adjustable ventilation
- 2D-Fit system
- Goggle retainer
- Beanie liner

SIZES AND WEIGHTS:

XS/S	M/L	XL/XXL
520 g	568 g	625 g

COLORS:

Black	ART.N°: 321503
Denim	ART.N°: 321513



Black

Denim

ECHO

ECHO is the multi-talented SENSOR's younger brother. The choice of colors and materials is designed for athletic, dynamic customers. This model impresses with the technical ingenuity of its TWIST STOP goggle mount, size adjustment system and our tried and tested BEANIE LINER with folding WINDSHIELD.

FEATURES:

- Height adjustable earpads
- Twist stop goggle retainer
- 2D-Fit system
- Integrated liner windshield

SIZES AND WEIGHTS:

XS/S	M/L	XL/XXL
375 g	395 g	415 g

COLORS:

Black	ART.N°: 324313
Ash	ART.N°: 324323



Black

Ash

GOGGLES

NUKE

A polycarbonate double lens with UV 400 protection, anti-fog coating and a 2-layer foam pad make our NUKE model the ideal pair of goggles for price-conscious winter sports enthusiasts who refuse to compromise on comfort and functionality.

FEATURES:

- Double-layer foam
- Sprayed polycarbonate double lens for maximum safety
- UV 400 protection
- anti-fog
- Inclusive goggle pouch

COLORS:

Black **ART.N°: 374612**
White **ART.N°: 374622**



Black



White

PROTECTION

FLEXOR UNIT

The UNIT is highly customisable with an extra-wide waist strap and size-adjustable SHOULDER and CONNECTOR STRAPS, and it also provides ultimate comfort and protection. In addition, the removable SHOULDER STRAPS make the UNIT FIS-compliant and suitable for racing use.

ART.N°: 395313

FEATURES:

- Perfectly dampening and highly energy absorbing with SAS TEC viscoelastic foam
- Antibacterial and odor-freeness life guarantee with Polygiene® 
- Removable protection unit
- FIS compatible with removable shoulder straps
- Height adjustable trouser connector straps

SIZES:

S – XXL



Unisex | Front



Unisex | Back

BAGS

SKI TRAVELBAG

ART.N°: 383703

FEATURES:

- Big wheelie bag with large main and various small compartments
- Stowable pull handle
- Business card window and high quality wheels

DIMENSIONS:

32x36x79 cm

VOLUME:

90l



SINGLE SKIBAG

ART.N°: 383713

FEATURES:

- Protective skibag for one pair of skis
- Length 170 cm – extendable to 190 cm
- Equipped with two buckled, easy-to-adjust compression straps and a comfortable carrying strap

DIMENSIONS:

190x15x32 cm

VOLUME:

89l



DOUBLE SKIBAG

ART.N°: 383733

FEATURES:

- Protective bag for two pairs of skis
- Extendable to a length of 195 cm
- Equipped with two buckled, easy-to-adjust compression straps and a comfortable carrying strap

DIMENSIONS:

190x15x45 cm

VOLUME:

123l



SKI DAYPACK

ART.N°: 383743

FEATURES:

- Daypack with zippered main and an external compartment
- Helmet holder
- Ergonomic mesh back padding
- Mesh water bottle pocket

DIMENSIONS:

33x18x48 cm

VOLUME:

28l



BOOT BAG

ART.N°: 383753

FEATURES:

- Shapely boot-carry-on-bag with comfortable handles and shoulder strap
- Zippered main and external compartment
- PP lining

DIMENSIONS:

44x27x39 cm

VOLUME:

46l



BOOT BACKPACK

ART.N°: 383763

FEATURES:

- Roomy zippered compartment and external zippered pouch
- Backing ergonomically padded

DIMENSIONS:

36x24x41 cm

VOLUME:

35l





FREESKI

**WHEN YOU ARE A SLAVE
ONLY TO FREEDOM. WHEN
TIME STOPS WHILE YOU
FLY. WHEN YOU SEE LINES
WHERE OTHERS SEE
DISASTER.**

WHAT'S YOUR LIMIT?

Paths are beaten to be abandoned, the unknown calls for exploration and the impossible needs a challenge. It's a fine line between sport, art and madness, and people who search for and ride that line are going further, charging steeper and flying higher every year. And while we know all about the laws of physics, we question them by experience:

**WE DREAM THE DREAM OF FLYING BEFORE WE FACE THE REALITY
OF LANDING – AND STILL LIVE TO TELL THE TALE.**



BIG MOUNTAIN SKI TECHNOLOGY | TTS

BIG MOUNTAIN SKIS WITH BEYOND RACE TECHNOLOGY

TTS – TIP AND TAIL STABILIZER SYSTEM.

A SKI WITH REDUCED VIBRATION AND INCREASED DAMPENING AND A SYSTEM TO INCREASE TORSIONAL STRENGTH ALL WHILE AT THE SAME TIME REDUCING SWING WEIGHT.

TTS is a stabilizing exoskeleton which dampens the vibrations normally felt from rockered tips and tails also reduces overall swing weight and creates a ski with a playful yet high level of performance. The system is comprised of an elastomeric inlay for vibration control as well as a glass fibre exoskeleton for stability and torsional strength. This combination not only reduces vibrations but creates better

pressure distribution upon entry and exit of a turn by minimizing lateral flex of the ski. Reducing overall vibration means better edge control and therefore increasing overall skiing performance and skier experience. In addition, the reduction of necessary core materials in the tips and tails has created a lighter swing weight for easier handling and maneuverability both on snow and in the air.

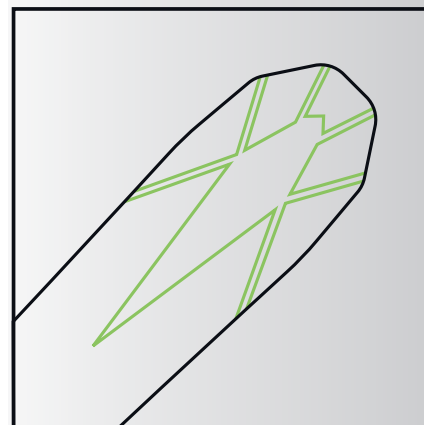

BINDING TECHNOLOGY | AAADRENALIN



AAADRENALIN – THE PERFECT ALL-ROUNDER

With the new AAAdrenalin Freeride binding from TYROLIA, no terrain is out of reach. This binding provides a level of skiing performance never before seen in an alpine binding. It combines performance driven freeride features with the ultimate ergonomic walking mechanism for maximum freedom on-and off-piste. Overcome boundaries smoothly for a perfect ride.

The AAAdrenalin binding is a perfect option for freeriders who prefer precise downhill control combined with ideal mechanics for short walks to reach untouched paths for a memorable ski experience. Designed together with freeskiers and backcountry skiers, this member of the TYROLIA AAA-Series is designed for ski widths from 80mm and wider. The AAAdrenalin brings paramount freeride performance in every terrain, on every slope.

BINDING TECHNOLOGY | AAADRENALIN

FREERIDE (FR) PRO TOE

The TYROLIA AAAadrenalin comes with the Freeride (FR) Pro Toe with its ergonomic pivot position for optimal tilt up movement up to 90 degrees. This system provides effortless walking over short distances. The FR Pro Toe is adjustable by changing the position of the Anti-Friction-Slider (AFS Metal) to cover alpine and touring boot norms. This 68mm wide slider plus a stainless steel gliding element provide constant release values and result in a broader contact area to the ski boot sole. The benefits: more stability, more direct power transmission and an ultimate skiing performance.



FREERIDE (FR) PRO HEEL

The ultra-wide 80mm heel track makes all the performance difference needed to take this product over the top. Extra width and the superior kinematics of TYROLIA's high performance bindings make it absolutely stable and reliable for perfect force transmission and unmatched performance. The heel can easily be adjusted to different boot sole lengths without any additional tools.

It covers a wide range of seven ski boot sizes. The AAAadrenalin freeride binding is available in two lengths:

SHORT (S) for ski boot sole length of 270-330mm

LONG (L) for ski boot sole length of 300-360mm

The TYROLIA AAAadrenalin comes without brakes. This gives each freerider the chance to choose the precisely fitting brakes in regard to the ski widths.

The AAAadrenalin 16 can be combined with brake widths of 88mm, 97mm, 115mm or 130mm. Brakes with a width of 88mm, 97mm or 115mm can be installed on the AAAadrenalin 13.



◀ 60mm ▶

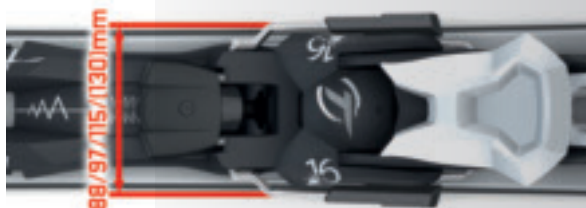

FREEFLEX

The platform of TYROLIA's AAAadrenalin binding provides the approved TYROLIA Freeflex function which allows the ski to flex as it is designed to do so it can retain its natural dynamics. Freeflex is enabled by the free gliding plate that runs within the titanal heel track and is supported by the center of rotation of the binding toe.



AAA ASCENDER LOCK AND CLIMBING AID

To Access All Areas, transition from skiing to hiking is incredibly fast, easy and convenient. Simply use the tip of the ski pole without stepping out of the binding to move the highly visible Ascender Lock to change between hiking and ski mode. Another TYROLIA feature is the possibility to walk in the 0° position. After release, TYROLIA's climbing aid can easily be operated with a ski pole and it can be positioned in three different angles (0°, 7° and 13°) for an optimal walking position. This improves balance and a secure stand on your way to perfect skiing spots. Additionally, TYROLIA crampons (available as spare parts in three widths: 90mm (ART.N°: 162977 – 1 Pair), 105mm (ART.N°: 162978 – 1 Pair) and 120mm (ART.N°: 162979 – 1 Pair)) can be mounted to improve grip in steep and icy terrain.

Whether skiing downhill or bridging walking paths, the TYROLIA AAAadrenalin gives adventurers an unrivaled combination of skiing performance and all terrain versatility, providing easy **ACCESS TO ALL AREAS**.





TURBINE 125

ART.N°: 311323

FEATURES:



- Sandwich cap construction
- Diecut UHM C base
- Tuffwalls
- ISS-Independent Suspension System
- TNT Rocker
- TTS

LENGTHS:

181/191

DIMENSIONS:

148/124/133 @ length 181

RADIUS:

19,0 @ length 181

SKILLS:

Level ■■■ Speed ■■■

BINDINGS:

ART.N°: 111605 AAAAdrenalin 16 long

ART.N°: 111604 AAAAdrenalin 16 short



CYCLIC 115

ART.N°: 311303

FEATURES:



- Sandwich cap construction
- Diecut UHM C base
- Tuffwalls
- ISS-Independent Suspension System
- TNT Rocker
- TTS

LENGTHS:

171/181/191

DIMENSIONS:

148/113/131 @ length 181

RADIUS:

19,0 @ length 181

SKILLS:

Level ■■■ Speed ■■■

BINDINGS:

ART.N°: 111615 AAAttack 16



COLLECTIVE 105

ART.N°: 311343

FEATURES:



- Sandwich cap construction
- Diecut UHM C base structured
- Tuffwalls
- ISS-Independent Suspension System
- TTS
- Allride Rocker

LENGTHS:

171/181/191

DIMENSIONS:

146/105/128 @ length 181

RADIUS:

17,5 @ length 181

SKILLS:

Level Speed

BINDINGS:

ART.N°: 111605 AAAdrenalin 16 long

ART.N°: 111604 AAAdrenalin 16 short

VENTURI 95

ART.N°: 311363

FEATURES:



- Sandwich cap construction
- Diecut UHM C base
- Tuffwalls
- ISS-Independent Suspension System
- TNT Rocker
- TTS

LENGTHS:

161/171/181/191

DIMENSIONS:

140/95/126 @ length 181

RADIUS:

16,0 @ length 191

SKILLS:

Level Speed

BINDINGS:

ART.N°: 111616 AAAttack 13 wide 97



FRESKI

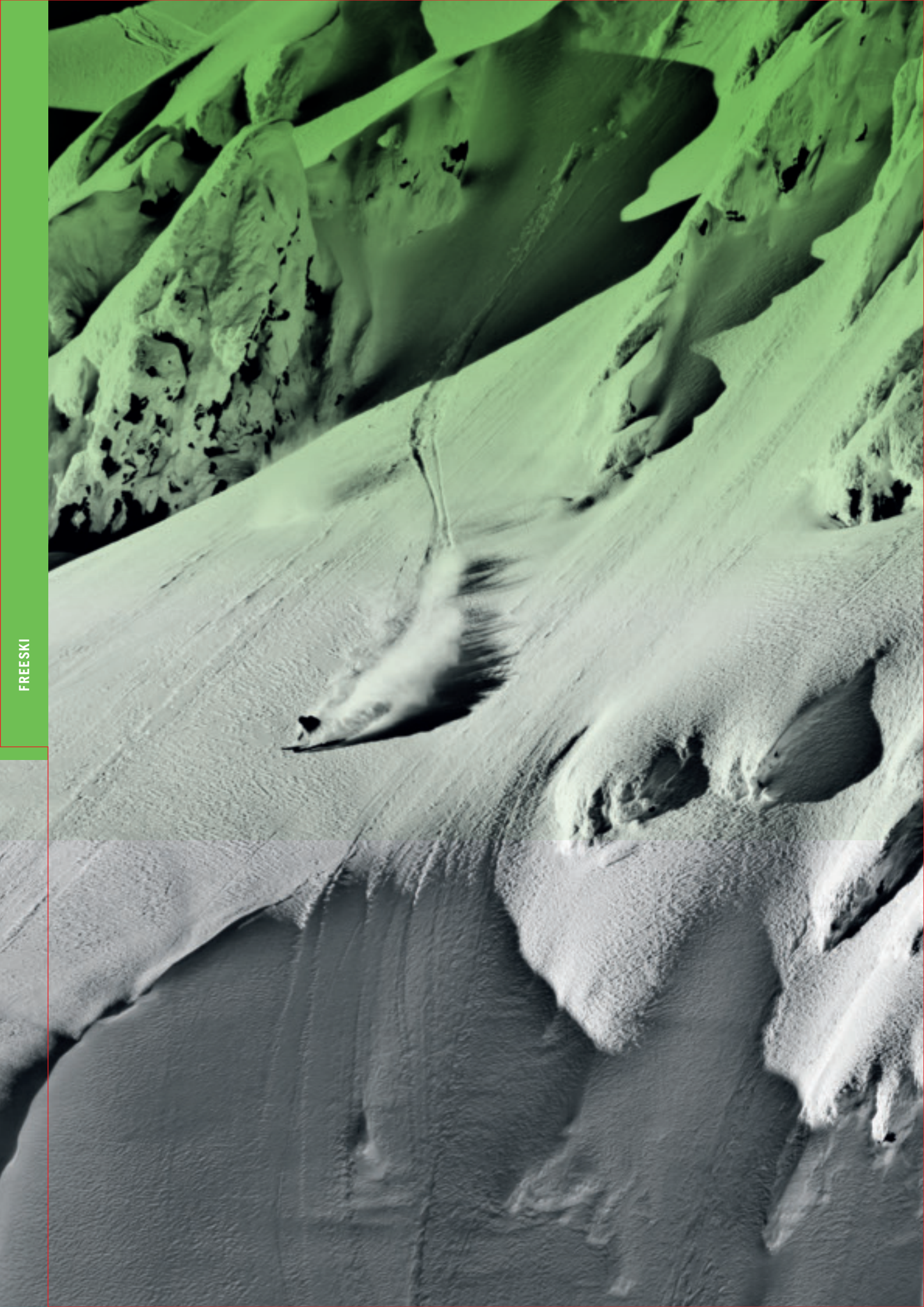

BOOTS

RAPTOR OVERKILL

ART.N°: 603008



LINER:

- HeatFit Pro liner
- HP frame footbed
- 50mm velcro strap

BUCKLES:

- 4 micro-adjustable Spine-Tech alloy buckles

FEATURES:

- Vibram® sole
- Racing flex stance tuning
- Rubber inserts
- Double canting
- Shock absorbing wedge

LEVEL:

Professional

FLEX INDEX:

140/130/120

SIZES:

260 – 265 – ... – 295

SHELL:

PU

LAST:

RS 1800cc

LAST	94	96	98
SIZE	25.5	26.5	27.5

COLOR:

Black/White



FRESKI

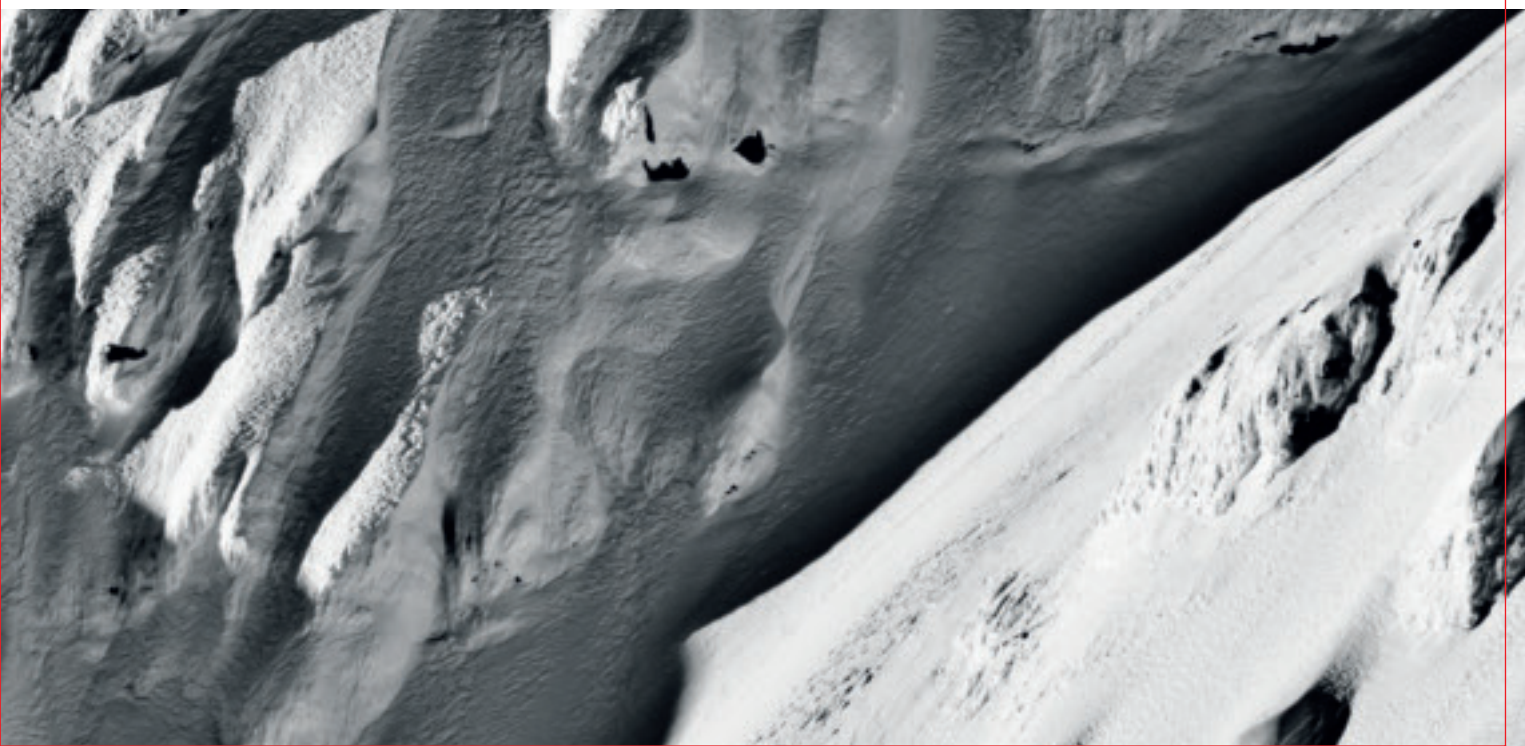

ALL COUNTRY

UPHILL AND DOWNHILL PERFORMANCE

The downhill company is now going up, but you don't have to miss the experience of coming back down. In the past a ski designed for going up meant you were sacrificing the experience of coming back down for weight savings on the trip up. However, now you can have a fully capable performance ski with the addition of lightweight materials to experience uphill and downhill freedom.

THE ANSWER TO FREEDOM IS ACCESS TO ALL

HEAD's All Country line is a series of skis with reduced weight core materials, waxable nano tech topsheets to prevent snow from sticking to the surface, as well as a clean approachable design. The freedom to choose and enjoy your path, both up and down is just the start of the journey.

BINDING TECHNOLOGY | AAAMBITION



AAAMBITION – THE TOURING NEWCOMER

The brand new TYROLIA AAAmbition Alpine Touring binding is the perfect companion for all Alpine Touring Aficionados so that no terrain remains unattainable. We included every attribute of our high-performance alpine ski bindings in this brand new Alpine Touring binding.

ALPINE TOURING TOE

This newcomer in the ski touring segment features the exclusive TYROLIA Alpine Touring (AT) Toe which can be easily adjusted to alpine and touring boot norms.

A 65mm wide mechanical AFS gliding element secures constant release values also with rubber soles. In combination with two rollers this binding provides superior safety features with the rapid and exact boot re-centering that skiers expect from TYROLIA. As a result of its harmonious design, the TYROLIA AAAmbition has a wider contact area which improves stability and provides a secure foundation for every skiing situation.

Furthermore, its pivot is efficiently positioned right below the ski boot tip to ensure perfect force transmission and a tilt up to 90 degree.

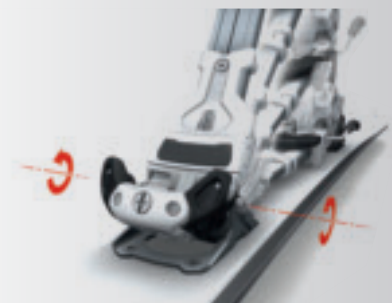

BINDING TECHNOLOGY | AAAMBITION

ONE-FOR-ALL EASY ADJUSTABLE TELESCOPIC TUBE

Additionally the AAAmbition features a unique light-weight telescopic tube which offers an easy adjustment opportunity to different boot sole lengths. Thus, with only one binding model it is possible to cover the entire range of different sole lengths – from 260mm up to 350mm. Furthermore, with the setting of the telescopic tube and through the compact mounting, perfect binding positioning on your skis is improved and mid-point deviation is avoided.



BRAKES & INDIVIDUALITY

Considering the different ski widths, the TYROLIA AAAmbition comes without brakes. This gives you the opportunity to either choose the perfect fitting brake out of three different widths (85 mm/105 mm/125 mm) or simply to ride and hike without brakes using appropriate powder straps.

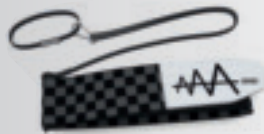

DEMO AND RENTAL SUITABLE

In order to offer ambitious sportsmen an opportunity to widen their horizons, the TYROLIA AAAmbition is also demo and rental suitable.

Combined with a spare demo track, this brand new TYROLIA binding can be tested and shown to a broad audience.

Only two easy adjustments (one on the telescopic tube and one on the demo track) are required to fit to different boot lengths without extra drilling.

To sum up: The new TYROLIA AAAmbition Alpine Touring binding is what every ski touring fanatic was looking for. On one hand it offers freedom and individual adjustment possibilities and on the other hand it provides the premium high-end performance that is expected from TYROLIA. The solid, light-weight construction and its maximum functionality enhances the ultimate mountain experience for ambitious climbers as well as for touring newbies. Overcome boundaries - Simply just: **ACCESS ALL AREAS!**

ALPINE TOURING HEEL AND CLIMBING AID

The newly designed climbing aid is positioned as close as possible to the Alpine Touring (AT) Heel. This provides better walking balance and effortless climbing in all situations. The low stand height of 38mm improves stability and offers a confident stance.

With four different climbing aid positions (climbing in a 0°, 5°, 10° or 15° position) it is possible to adapt on different terrains without stepping out of the binding.

It does not matter if it is a walk through flat terrain or a steep slope up to the summit. Simply use the ski pole in order to change the climbing aid position and also to lock for the downhill ride.

Additional crampons are available as spare parts in widths of 90 mm, 105 mm and 120 mm, and provide safe climbing and a secure stand in any situation.

- 90mm: ART.N°: 163006 (1 Pair)
- 105mm: ART.N°: 163007 (1 Pair)
- 120mm : ART.N°: 163008 (1 Pair)

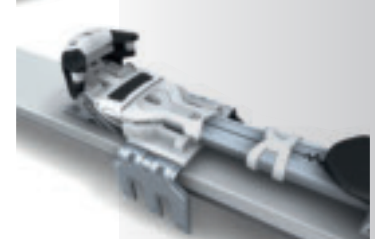

TYROLIA FREEFLEX

The TYROLIA approved Freeflex System, which interacts with the AT Toe, the telescopic tube and the AT Heel, offers natural dynamics, excellent downhill performance and therefore a supreme ski touring experience.

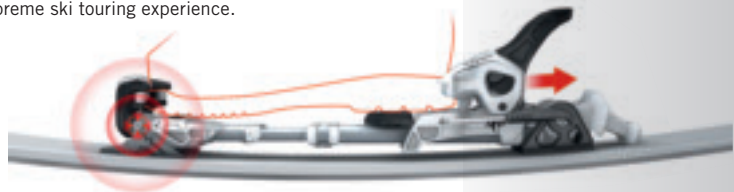

◀ 90mm ▶





ALL COUNTRY



ALL COUNTRY SKINS

COMPOSITION: 65% MOHAIR AND 35% NYLON



PROTOSTELLAR 98

ART.N°: 310703

FEATURES:



- ERA 3.0
- Sandwich cap construction
- Nano Tech surface
- Skins need to be ordered separately (ART.N°: 388123)

LENGTHS:

156/163/170/177/184

DIMENSIONS:

137/98/123 @ length 170

RADIUS:

15,3 @ length 170

SKILLS:

Level III Speed III

BINDINGS:

ART.N°: 111612 AAAmbition 12
Solid Blue/Yellow

ART.N°: 111610 AAAmbition 12
Solid White/Black



GALACTIC 84

ART.N°: 310733

FEATURES:



- ERA 3.0
- Sandwich cap construction
- Nano Tech surface
- Skins need to be ordered separately (ART.N°: 388133)

LENGTHS:

149/156/163/170/177/184

DIMENSIONS:

134/84/116 @ length 170

RADIUS:

14,3 @ length 170

SKILLS:

Level III Speed III

BINDINGS:

ART.N°: 111612 AAAmbition 12
Solid Blue/Yellow

ART.N°: 111610 AAAmbition 12
Solid White/Black



NEBULA 78

ART.N°: 310753

FEATURES:



- ERA 3.0
- Woodcore cap construction
- Nano Tech surface
- Skins need to be ordered separately (ART.N°: 388143)

LENGTHS:

142/149/156/163/170/177

DIMENSIONS:

131/78/113 @ length 170

RADIUS:

13,2 @ length 170

SKILLS:

Level III Speed III

BINDINGS:

ART.N°: 111612 AAAmbition 12
Solid Blue/Yellow

ART.N°: 111610 AAAmbition 12
Solid White/Black

BOOT TECHNOLOGY I VENTURE

SKI/TOUR MECHANISM

The Ski/Tour mechanism is the right combination between skiing and touring. Providing a perfect lock of the shell during the downhill activities for the maximum performance, yet offering an easy release for the return trip.

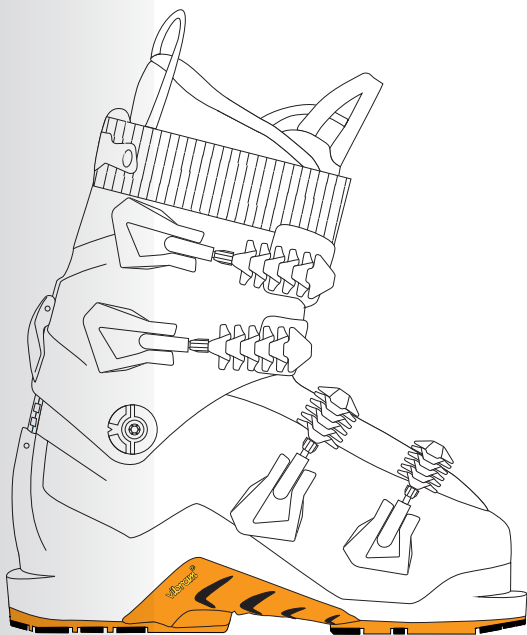

SKI

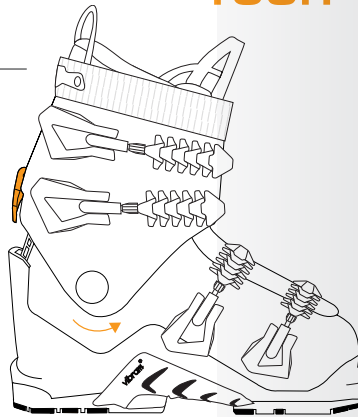

TOUR



VIBRAM® SOLE

The bi-injected Vibram® sole allows safe hiking on all terrain while reducing shock absorption as well.

VIBRAM® TOURING PADS

Interchangeable Vibram® Touring Pads - an innovative high performance rubber sole provides the maximum grip when hiking on anything from rocks on a peak to the parking lot ice. Please refer to the international standard "ISO 9523".

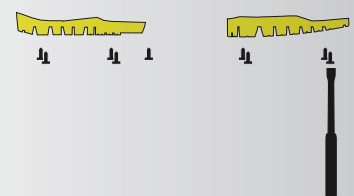
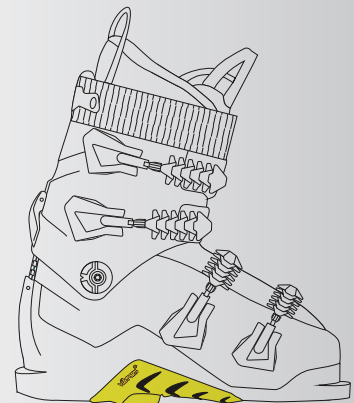
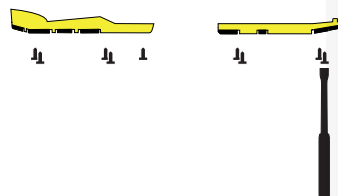
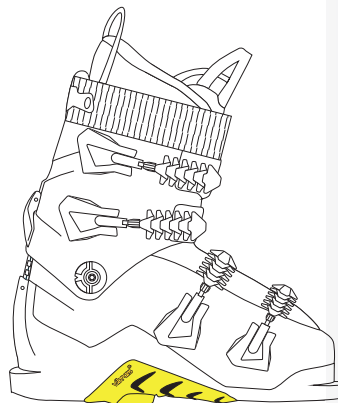

BOOTS

VENTURE 130

ART.N°: 603015



LINER:

- Perfect Fit HP Pro FR liner
- HP frame footbed
- 40mm velcro strap

BUCKLES:

- 4 micro-adjustable Spineflex alloy buckles
- 1 supermacro ratchet

FEATURES:

- Bi-Inj. frame
- Vibram® sole
- Ski-Hike mechanism
- Lacing option
- Touring sole option
- Shock absorbing wedge

LEVEL:

Professional

FLEX INDEX:

130

SIZES:

250 - 255 - ... - 305

SHELL:

PU

LAST:

RS 1900cc

LAST	96	98	100
SIZE	25.5	26.5	27.5

COLOR:

White/Light Blue



VENTURE 120

ART.N°: 603018



LINER:

- Perfect Fit HP Pro FR liner
- HP frame footbed
- 40mm velcro strap

BUCKLES:

- 4 micro-adjustable Spine-Tech alloy buckles
- 1 supermacro ratchet

FEATURES:

- Bi-Inj. frame
- Vibram® sole
- Ski-Hike mechanism
- Lacing option
- Touring sole option
- Shock absorbing wedge

LEVEL:

Professional

FLEX INDEX:

120

SIZES:

250 - 255 - ... - 305

SHELL:

PU

LAST:

RS 1900cc

LAST	96	98	100
SIZE	25.5	26.5	27.5

COLOR:

White/Black

POLES



3550 VARIO TWO PIECE

ART.N°: 381513

COLOR:

Black/White/Red

DIAMETER Ø:

16/14 mm

LENGTHS:

110 – 140 cm

FEATURES:

- Two-part telescope pole
- 7075 Aluminum
- Positive angle safety bi-injected soft grip
- Lock security neoprene strap
- LEKI speed lock
- Carbide flex tip long
- Vision race basket 50 mm & additional 95 mm powder basket
- Packing length 84 cm



3312 VARIO THREE PIECE

ART.N°: 381523

COLOR:

Red/Yellow

DIAMETER Ø:

18/16/14 mm

LENGTHS:

110 – 150 cm

FEATURES:

- Three-part telescope touring pole
- 7075 Aluminum
- Round top comfort soft grip
- LEKI speed lock
- Carbide flex tip long
- 95 mm powder basket
- Packing length 70 cm

SKI TECHNOLOGY | PARK & PIPE

PNP ROCKER

Park and Pipe Rocker incorporates very subtle tip and tail rise with regular camber construction underfoot. PNP Rocker provides a rider a smoother turn initiation as well as reduced edge contact to seamlessly butter into tricks and initiate spins. With 30% rocker and 70% camber, the ski will perform like an all mountain carving ski, yet pop onto rails and boxes with ease with a stiff construction and substantial rebound effectiveness.

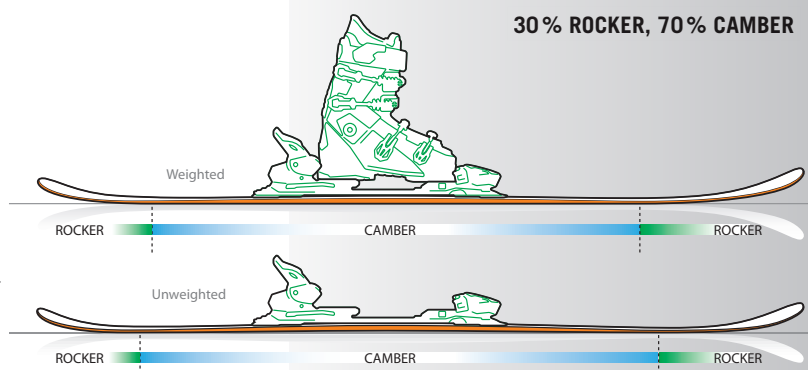

BINDING TECHNOLOGY | AAATTACK



AAATTACK – ASTONISHING PARK & PIPE ACTION

Freeskiers prefer equipment which provides control, performance and usability. Not only for clear slopes and untracked powder areas, also for stoked park and half pipe rides. The new AAAttack binding by TYROLIA combines functionality and modern design to meet these demands. A perfect tool for all-around skiers who are willing to attack!

MODERN ARCHITECTURE

The special Freeride (FR) Pro Toe with its horizontal spring reflects the modern architecture of the new TYROLIA AAA-Series. Furthermore, it includes a super secure 77 mm metal friction device (AFD Metal), which can be adjusted for all types of alpine boots (Type A only).

The AAAttack 16 features the TYROLIA Race Pro Heel, with a reduced stand height of only 17 mm for the ultimate freeski adventure.



PERFECT INDIVIDUALITY

The built in AAA-Series technology ensures high quality and perfect usability. In regard to its clear design and its compact measurement, the AAAttack model can be ideally used on ski widths from 80 mm and wider. TYROLIA's brand new designed AAAttack binding is available in two different DIN settings (16 and 13). The AAAttack 13 features a solid construction, reduced weight and a new designed heel, which brings this model to a new level. Some models are delivered without brakes.

This gives riders the opportunity to customize the setup to their needs. Brakes are available in different widths: 88 mm, 97 mm, 115 mm, 130 mm and 150 mm.

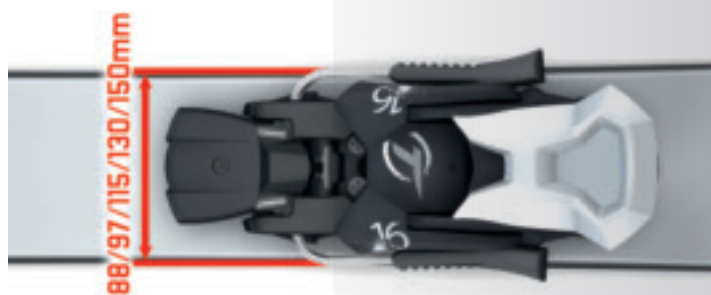

DEMO & RENTAL SUITABLE

The AAAttack 13LT model, a demo and rental version with the proven TYROLIA Sympro Heel track, offers the opportunity for easy adjustment to fulfill customer's desires and to adapt to the wide range of different sole lengths. It comes in two lengths: Short (S) (sole range from 260 mm – 320 mm) and Long (L) (sole range from 300 mm – 360 mm). Both tracks come with the binding, with the long track pre-mounted.

Attack the track with this brand new TYROLIA freeski binding! Overcome boundaries – simply just: **ACCESS ALL AREAS!**





THE CADDY

ART.N°: 311423

FEATURES:



- Sandwich twintip construction
- Highly transparent UHM base
- Tuffwalls
- ISS-Independent Suspension System
- PNP Rocker

LENGTHS:

171/176/181

DIMENSIONS:

121/84/110 @ length 181

RADIUS:

20,2 @ length 181

SKILLS:

Level Speed

BINDINGS:

ART.N°: 111615 AAAttack 16



OBLIVION #2

ART.N°: 311403

FEATURES:

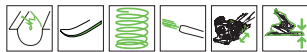

- Sandwich twintip construction
- Highly transparent UHM base
- Tuffwalls
- ISS-Independent Suspension System
- PNP Rocker

LENGTHS:

171/176/181

DIMENSIONS:

132/90/119 @ length 181

RADIUS:

18,0 @ length 181

SKILLS:

Level ■■■ Speed ■■■

BINDINGS:

ART.N°: 111616 AAAttack 13 wide 97



THE SHOW

ART.N°: 311443

FEATURES:



- Twintip construction
- Highly transparent UHM base
- Tuffwalls
- PNP Rocker

LENGTHS:

154/163/172/181

DIMENSIONS:

112/79/106 @ length 172

RADIUS:

19,1 @ length 172

SKILLS:

Level ■■■ Speed ■■■

BINDINGS:

ART.N°: 111617 AAAttack 13

BOOTS

RAPTOR OBLIVION

ART.N°: 603009



LINER:

- HeatFit Pro liner
- HP frame footbed
- 50mm velcro strap

BUCKLES:

- 4 micro-adjustable Spine-Tech alloy buckles

FEATURES:

- Racing flex stance tuning
- Rubber inserts
- Double canting
- Shock absorbing wedge

LEVEL:

Expert

FLEX INDEX:

135/125/115

SIZES:

260 – 265 – ... – 295

SHELL:

PU

LAST:

RS 1800cc

LAST	94	96	98
SIZE	25.5	26.5	27.5

COLOR:

Black



FRESKI

POLES



AERO

ART.N°: 381333

COLOR:

Sublimated

DIAMETER Ø:

18 mm

LENGTHS:

110 – 135 cm

FEATURES:

- 7075 Aluminum
- Bi-injected grip
- Automatic strap
- Alpine basket 50 mm white & 92 mm powder basket blue
- ICE carbide tip

BOOT TECHNOLOGY | PARK & PIPE

SHOCK ABSORPTION WEDGE

A rubberized boot board that allows for smoother riding over varied terrain as well as an additional layer of protection from impact to create a shock-free landing.

P&P – HIGHER LINER

High Profile P&P liner to grant the best support and comfort when landing.

BOOTS

THE SHOW 1

ART.N°: 603401



LINER:

- HeatFit liner
- Sport frame footbed
- 50 mm velcro strap
- High profile liner

BUCKLES:

- 2 micro-adjustable alloy buckles
- 1 micro-adjustable wide-body alloy buckle
- 1 supermacro ratchet

FEATURES:

- Bi-Inj power control frame
- SoftWalk heel + grip system
- Double rivet cuff
- Shock absorbing wedge

LEVEL:

Intermediate

FLEX INDEX:

100

SIZES:

250 – 260 – 265 – ... – 305

SHELL:

PU/SL

LAST:

EC 2200cc

LAST	102	104	106
SIZE	25.5	26.5	27.5

COLOR:

White



THE SHOW 2

ART.N°: 603402

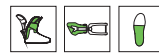

LINER:

- HeatFit liner
- Sport frame footbed
- 50 mm velcro strap

BUCKLES:

- 2 micro-adjustable alloy buckles
- 1 micro-adjustable wide-body alloy buckle
- 1 supermacro ratchet

FEATURES:

- Bi-Inj power control frame
- SoftWalk heel + grip system
- Shock absorbing wedge

LEVEL:

Beginner – Intermediate

FLEX INDEX:

90

SIZES:

250 – 260 – 265 – ... – 305

SHELL:

SL

LAST:

EC 2200cc

LAST	102	104	106
SIZE	25.5	26.5	27.5

COLOR:

Black/White

HELMETS

PRO

An old flame, a new look. Not least because our PRO is the lightest helmet in our programme, our freestyle team has chosen it as their head-protector of preference. With the HEAD FREE-STYLE logo, BEANIE LINER with WINDSHIELD and size adjustment system, the PRO continues to amaze on into the new year. Purchase tip of the "All Mountain Magazine 2012/11"

FEATURES:

- Thermal ventilation
- Removable earpads
- 2D-Fit System
- Integrated liner windshield

SIZES AND WEIGHTS:

XS/S	M/L	XL/XXL
385g	400g	425g

COLORS:

Black	ART.N°: 324413
Ash	ART.N°: 324423



Black

Ash

REBEL

The ideal accessory for a day on the slopes is light, boasts a perfect fit, and offers the best protection in any situation. The REBEL fulfils these requirements exactly, and that's why for years now it has been one of the most popular helmets in our programme. It is also available in AUDIO version.

FEATURES:

- Thermal ventilation
- Removable earpads
- 2D-Fit System
- Removable beanie liner

SIZES AND WEIGHTS:

XS/S	M/L	XL/XXL
385g	400g	425g

COLORS:

Black	ART.N°: 324613
Red/Blue	ART.N°: 324623
Green/Lime	ART.N°: 324633



Black

Red/Blue

Green/Lime

HELMETS

REBEL AUDIO

ART.N°: 324603

FEATURES:

- Audio-earphones placed into the earpads
- Thermal ventilation
- Removable earpads
- 2D-Fit System
- Removable beanie liner

SIZES AND WEIGHTS:

XS/S	M/L	XL/XXL
400g	415g	440g

COLOR:

Black



GOGGLES

HORIZON

The name says it all. HEAD's free-style outfit HORIZON goggles impress with their slim frames and the resultant increase in the field of vision. The silicone-coated straps ensure a non-slip grip, while the 3-layer foam pad provides maximum comfort.

FEATURES:

- Sprayed polycarbonate lens for maximum safety
- UV400 protection & anti-fog
- Double lens
- triple-layer foam
- Silicon layer
- Extreme wide field of vision
- Compatible with HEAD helmets

COLORS:

Black
Ash

ART.N°: 373513
ART.N°: 373523



BAG TECHNOLOGY | ABS®

ABS® TWINBAG FOR LIFE

A QUICK TUG ON THE ABS® TWINBAG'S ACTIVATION HANDLE IS ALL IT TAKES TO INSTANTLY INFLATE TWO AIRBAGS WITH A TOTAL VOLUME OF 170 LITERS. THIS EXTRA VOLUME WILL ALMOST CERTAINLY PREVENT THE WEARER FROM BEING BURIED IN AN AVALANCHE.

Two separate airbag chambers make the ABS® system twice as reliable. If one airbag is damaged during the descent, the other will remain inflated for a sufficient length of time. The wide bearing surface due to laterally placed Twin-Bags stabilizes the body and increases the lifting effect precisely in the critical avalanche run-out zone. Of the 262 persons who activated their ABS® avalanche airbag, 97 % survived and 84 % of those were uninjured.*

* Source: SLF, known and documented avalanche accidents with ABS® avalanche airbags, August 2010.



ABS® COMPATIBLE*

The ABS® Avalanche Airbag is the original self-rescue system – produced and tested by German avalanche experts since 1985. There are also other, wellknown companies that rely on ABS® and have included backpacks in their product range that are compatible with the ABS®-System. This backpack is especially designed to fit onto the Base Unit with integrated ABS® TwinBag system by means of a zip.

* The ABS®-System is not included in delivery.

BAGS

SKI FREERIDE BACKPACK

ART.N°: 383533

FEATURES:

- Water proof zippers
- Velcro padded waist belt
- Horizontal and dual vertical ski carry options
- Vertical snowboard carry straps
- Storable ski carry and Ice Axe straps
- Internal snow tools and shovel pockets
- Helmet carrying system
- Sternum chest strap

DIMENSIONS:

33x58x14 cm

VOLUME:

25l



BAGS

PEAK FELLOW

With the newly-developed PEAK FELLOW, the HEAD development team has surpassed itself and developed a product that combines all the features you need for a perfect day's skiing or snowboarding. The result is a freeride backpack that provides as much security and functionality as you could ever wish for.

The PEAK FELLOW is the ideal accessory for backcountry use. In addition to storage space for avalanche emergency equipment, including a shovel, a probe and a first-aid kit, the packsack's ABS® compatibility offers yet more safety on insecure terrain. The ABS® system is a TÜV-approved airbag system that can save you from being buried in an avalanche. Pull the handle and the ABS® twin bags are pyrotechnically and pneumatically activated, inflating to full size in a split second. The inflated ABS® twin bags provide additional dynamic lift in a flowing avalanche, and help skiers and snowboarders to stay on top of the avalanche. The separately available ABS® VARIO BASE UNIT can be zipped onto the HEAD PEAK FELLOW packsack in just a few steps.

The removable back protector built into the PEAK FELLOW's carrying compartment is CE EN 1621-2

certified and offers additional impact protection. On the outside of the backpack there are attachments for poles, an ice axe and a helmet. The main compartment provides enough space for anything you can't do without for a long day on the slopes, and closes tight with the help of the water-repellent YKK zipper. Smart storage compartments for a hydration system, tools, a mobile phone and other small items complete the list of features.

Despite its compact outer dimensions, the PEAK FELLOW offers a unique variety of attachments for carrying skis or snowboards. Skis can be attached either one on each side or diagonally. Boards can be mounted across the backpack during trips on the snowmobile, or vertically down the length of the body while climbing on foot.

ART.N°: 374563



FEATURES:

- Compatible to all ABS® vario base units
- Inside & outside storage system
- Removable, multiimpact absorbing and certified back-protector
- Hydration system compatible
- Water resistant ripstop material and zippers

VOLUME:

18l



BAGS



TRAVEL BAG SM

ART.N°: 374423

FEATURES:

- Water resistant material
- Laundry bag
- Velcro adjustable packing compartments
- Heavy duty webbing reinforcements
- Extra strong YKK zipper

VOLUME:

99l



FRESKI



STREET BACKPACK

ART.N°: 374483

FEATURES:

- Water resistant material
- Dual padded laptop pocket
- Sound pocket
- Ergonomically padded shoulder straps
- Inside & outside storage system

VOLUME:

16l

LEARJET

ART.N°: 374433

FEATURES:

- Water resistant material
- Extra strong YKK zipper
- Bottom & edge protection
- 3 stop telescope handle
- Inside & outside storage system

VOLUME:

38,5l

APPAREL

DCT T-SHIRT MEN

ART.N°: 378753

SIZES:

S - XXL



LOGO T-SHIRT MEN

ART.N°: 378793

SIZES:

S - XXL



POCKET T-SHIRT MEN

ART.N°: 378783

SIZES:

S - XXL



POLO BLACK

ART.N°: 378803

SIZES:

S - XXL



POLO CYAN

ART.N°: 378813

SIZES:

S - XXL



TRIBUTE T-SHIRT MEN

ART.N°: 378773

SIZES:

S - XXL



APPAREL

PROTECTION HOODY MEN

ART.N°: 378863

SIZES:

S – XXL



HOODY MEN

ART.N°: 378723

SIZES:

S – XXL



PROTECTION T-SHIRT MEN

ART.N°: 378873

SIZES:

S – XXL



DENIM SHIRT MEN

ART.N°: 378733

SIZES:

S – XXL



BEANIE BLACK

ART.N°: 378903

SIZES:

One size



BEANIE GREY

ART.N°: 378913

SIZES:

One size



BEANIE RED

ART.N°: 378923

SIZES:

One size





WOMEN

**WHEN YOU TURN DOUBT
INTO DETERMINATION.
WHEN A DAY ON THE
MOUNTAIN GIVES YOU
MORE ENERGY THAN YOU
SPEND. WHEN YOUR GEAR
FINALLY MEETS YOUR
ASPIRATIONS.
WHAT'S YOUR LIMIT?**

True love for skiing is unconditional. It's not about flawlessness, prettiness, or prowess. It's about expressing yourself, not impressing others. Faith moves mountains, confidence skis them – from daybreak until nightfall. Whatever your line and your limit:

THE RIGHT EQUIPMENT WILL TURN BAD WEATHER INTO GOOD KARMA, TERRIBLE HAIR DAYS INTO BIG AIR DAYS, AND I-DON'T-WANT-TO-RUN-DAYS INTO OUNCES OF PURE, STRIKING GOLD.

WOMEN





MYA NO. 10

ART.N°: 311623

FEATURES:



- TTS
- Tuffwalls
- Allride Rocker
- Sandwich cap construction
- Diecut UHM C base structured
- ISS – Independent Suspension System

LENGTHS:

171/181

DIMENSIONS:

145/104/127 @ length 171

RADIUS:

15,3 @ length 171

SKILLS:

Level **■■■** Speed **■■■**

BINDINGS:

ART.N°: 100536 MYA 12 LX



MYA NO. 9

ART.N°: 311683

FEATURES:



- ERA 3.0
- Sandwich cap construction
- Structured UHM C base

LENGTHS:

156/163/170/177

DIMENSIONS:

137/98/123 @ length 170

RADIUS:

15,3 @ length 170

SKILLS:

Level **■■■** Speed **■■■**

BINDINGS:

ART.N°: 100536 MYA 12 LX



MYA NO. 8

ART.N°: 311683

FEATURES:



- ERA 3.0
- Sandwich cap construction
- Structured UHM C base

LENGTHS:

149/156/163/170

DIMENSIONS:

130/84/112 @ length 163

RADIUS:

13,3 @ length 163

SKILLS:

Level **■■■** Speed **■■■**

PLATES:

PowerRail

BINDINGS:

ART.N°: 100538 MYA 10 PR wide 90

BOOTS

RAPTOR 110 MYA

ART.N°: 603012



LINER:

- Women's HeatFit Pro liner
- HP frame footbed
- 40mm velcro strap

BUCKLES:

- 4 micro-adjustable Spine-Tech alloy buckles

FEATURES:

- Racing flex tuning
- Double canting
- FIS approved sole thickness

LEVEL:

Professional

FLEX INDEX:

110/100

SIZES:

220 – 230 – ... – 275

SHELL:

JR Shell

LAST:

RS 1800cc

LAST	94	96	98
SIZE	25.5	26.5	27.5

COLOR:

Black



CHALLENGER 110 MYA

ART.N°: 603035

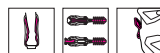

LINER:

- Women's Perfect Fit S liner
- HP frame footbed
- 40mm velcro strap

BUCKLES:

- 4 micro-adjustable Spine-Tech alloy buckles
- 1 supermacro ratchet

FEATURES:

- Bi-Inj. frame
- Adaptive Fit Technology
- Ski-Hike mechanism
- Easy Entry shell design
- Flex tuning
- Double canting
- Rear support tuning

LEVEL:

Expert

FLEX INDEX:

110/100

SIZES:

230 – 235 – ... – 275

SHELL:

PU/SL

LAST:

S 2000cc

LAST	97-99	99-101	101-103
SIZE	25.5	26.5	27.5

COLOR:

Trsp Anthr./Black

BOOTS

DREAM 100 MYA

ART.N°: 603525



LINER:

- Women's HP HeatFit liner
- Fur lining and Thermaluxe tips
- Self-shaping footbed with Sanitized®
- 30 mm velcro strap
- Prepared for heating system

BUCKLES:

- 4 micro-adjustable Spine-Tech magnesium buckles
- 2 Double Power levers
- 1 supermacro ratchet
- Easy Entry instep ratchet

FEATURES:

- Stiffer/softer flex adjustment
- Adjustable wedge arch support
- Double canting
- Double adjustable profile

- SoftWalk heel + grip system
- Women specific supportive heel option

LEVEL:

Expert

FLEX INDEX:

100/90

SIZES:

220 - 230 - ... - 275

SHELL:

PU

LAST:

WP 1950cc

LAST	98	100	102
SIZE	25.5	26.5	27.5

COLOR:

Trsp. Pearl



DREAM 90 MYA

ART.N°: 603531



LINER:

- Women's HeatFit liner
- Fleece lining and Thermaluxe tips
- Self-shaping footbed with Sanitized®
- 30 mm velcro strap
- Prepared for heating system

BUCKLES:

- 4 micro-adjustable Spine-Tech magnesium buckles
- 2 Double Power levers
- 1 supermacro ratchet
- Easy Entry instep ratchet

FEATURES:

- Stiffer/softer flex adjustment
- Adjustable wedge arch support
- Double canting
- Double adjustable profile

- SoftWalk heel
- Women specific supportive heel option

LEVEL:

Advanced

FLEX INDEX:

90/80

SIZES:

220 - 230 - ... - 275

SHELL:

SL

LAST:

WP 1950cc

LAST	98	100	102
SIZE	25.5	26.5	27.5

COLOR:

Anthracite

DREAM 80 MYA

ART.N°: 603540



LINER:

- Women's HeatFit liner
- Fleece lining and Thermaluxe tips
- Self-shaping footbed with Sanitized®
- 30 mm velcro strap
- Prepared for heating system

BUCKLES:

- 4 micro-adjustable Spine-Tech magnesium buckles
- 1 supermacro ratchet
- Easy Entry instep ratchet

FEATURES:

- Adjustable wedge arch support
- Double canting
- Double adjustable profile
- SoftWalk heel
- Women specific supportive heel option

LEVEL:

Advanced

FLEX INDEX:

80

SIZES:

220 - 230 - ... - 275

SHELL:

SL

LAST:

WP 1950cc

LAST	98	100	102
SIZE	25.5	26.5	27.5

COLOR:

White





MYA NO. 7

ART.N°: 311603

FEATURES:



- ERA 3.0 S
- KERS
- WC sandwich construction
- Highly transparent UHM base
- 3D surface

LENGTHS:

149/156/163/170

DIMENSIONS:

118/66/97 @ length 163

RADIUS:

13,2 @ length 163

SKILLS:

Level III Speed III

PLATES:

PowerRail Pro

BINDINGS:

ART.N°: 100535 MYA 12 PRD

MYA NO. 6

ART.N°: 311753

FEATURES:

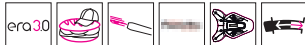

- ERA 3.0
- Sandwich cap construction
- Highly transparent UHM base
- 3D surface

LENGTHS:

142/149/156/163/170

DIMENSIONS:

127/79/109 @ length 156

RADIUS:

11,2 @ length 156

SKILLS:

Level III Speed III

PLATES:

PowerRail

BINDINGS:

ART.N°: 100540 MYA 10 PR





MYA NO. 5

ART.N°: 311763

FEATURES:



- ERA 3.0
- Sandwich cap construction
- Highly transparent UHM base
- Diffusor
- 3D surface

LENGTHS:

142/149/156/163

DIMENSIONS:

123/71/107 @ length 156

RADIUS:

10,8 @ length 156

SKILLS:

Level ■■■ Speed ■■■

PLATES:

PowerRail

BINDINGS:

ART.N°: 100539 MYA 10 PR



MYA NO. 4

ART.N°: 311773

FEATURES:



- ERA 3.0
- Power sidewall jacket
- Highly transparent UHM base
- 3D surface

LENGTHS:

142/149/156/163

DIMENSIONS:

125/77/108 @ length 156

RADIUS:

11,1 @ length 156

SKILLS:

Level ■■■ Speed ■■■

PLATES:

LiteRail

BINDINGS:

ART.N°: 111543 MYA 9 LRX



MYA NO. 3

ART.N°: 311743

FEATURES:

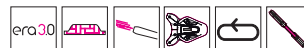

- ERA 3.0
- Power carbon jacket
- Highly transparent UHM base

LENGTHS:

142/149/156/163

DIMENSIONS:

121/69/105 @ length 156

RADIUS:

10,5 @ length 156

SKILLS:

Level ■■■ Speed ■■■

PLATES:

LiteRail

BINDINGS:

ART.N°: 100544 MYA 9 LRX

ADAPTEGE 100 MYA

ART.N°: 603114

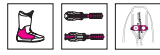
**LINER:**

- Women's HP HeatFit liner
- Sport frame footbed
- 40mm velcro strap

BUCKLES:

- 4 micro-adjustable Spine-Tech alloy buckles
- 2 Double Power levers
- 1 supermacro ratchet

FEATURES:

- Tri-Inj. energy frame
- Adaptive Fit Technology

- Easy Entry shell design
- Stiffer/softer flex adjustment
- Double canting
- Adjustable rear spoiler
- SoftWalk heel + grip system

LEVEL:

Advanced

FLEX INDEX:

90/80

SIZES:

220 - 230 - 23 - ... - 275

SHELL:

PU/SL

LAST:

C 2100cc

LAST	100-98	102-100	104-102
SIZE	25.5	26.5	27.5

COLOR:

Tspr. Pearl/White

ADAPTEGE 90 MYA

**LINER:**

- Women's HeatFit liner
- Sport frame footbed
- 40mm velcro strap

BUCKLES:

- 4 micro-adjustable alloy buckles
- 2 Double Power levers
- 1 supermacro ratchet

FEATURES:

- Tri-Inj. energy frame
- Adaptive Fit Technology

- Easy Entry shell design
- Stiffer/softer flex adjustment
- Double canting
- Adjustable rear spoiler
- SoftWalk heel + grip system

LEVEL:

Advanced

FLEX INDEX:

80/70

SIZES:

220 - 230 - 235 - ... - 275

SHELL:

SL

LAST:

C 2100cc

LAST	100-98	102-100	104-102
SIZE	25.5	26.5	27.5

COLORS:

Tspr./White

ART.N°: 603145

Tspr./Black

ART.N°: 603146

NEXTEGE 80 MYA

ART.N°: 603180

**LINER:**

- Women's HeatFit liner
- Sport frame footbed
- 40mm velcro strap
- Prepared for heating system

BUCKLES:

- 4 micro-adjustable alloy buckles
- 1 supermacro ratchet

FEATURES:

- Tri-Inj. energy frame
- Easy Entry shell design

- Double canting
- SoftWalk heel

LEVEL:

Advanced

FLEX INDEX:

70

SIZES:

220 - 230 - 235 - ... - 275

LAST:

C 2100cc

LAST	100	102	104
SIZE	25.5	26.5	27.5

COLOR:

White/Silver

NEXTEGE 70 MYA

**LINER:**

- Comfort liner
- Sport frame footbed
- 40mm velcro strap

BUCKLES:

- 4 micro-adjustable plastic buckles
- 1 supermacro ratchet

FEATURES:

- Tri-Inj. energy frame
- Easy Entry shell design

- Double canting
- SoftWalk heel

LEVEL:

Intermediate

FLEX INDEX:

60

SIZES:

220 - 230 - 235 - ... - 275

LAST:

C 2100cc

LAST	100	102	104
SIZE	25.5	26.5	27.5

COLORS:

White/Silver

ART.N°: 603235

Black/Anthracite

ART.N°: 603236

CUBE3 12 MYA

ART.N°: 603325



LINER:

- Women's SuperHeat3 quick entry liner
- Sport frame footbed
- 35mm velcro strap

BUCKLES:

- 2 micro-adjustable alloy buckles
- 1 micro-adjustable wide-body alloy buckle
- 1 supermacro ratchet

FEATURES:

- Bi-Inj power control frame
- Integrated AutoSkiWalk
- SoftWalk heel + grip system

LEVEL:

Advanced

FLEX INDEX:

80

SIZES:

230 – 235 – ... – 275

SHELL:

PU/SL

LAST:

EC 2200cc

LAST	102	104	106
SIZE	25.5	26.5	27.5

COLOR:

Trsp./White



CUBE3 10 MYA

ART.N°: 603335

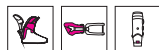

LINER:

- Women's HeatFit quick entry liner
- Sport frame footbed
- 35mm velcro strap

BUCKLES:

- 2 micro-adjustable alloy buckles
- 1 micro-adjustable wide-body alloy buckle
- 1 supermacro ratchet

FEATURES:

- Bi-Inj power control frame
- Integrated AutoSkiWalk
- SoftWalk heel + grip system

LEVEL:

Intermediate

FLEX INDEX:

70

SIZES:

230 – 235 – ... – 275

SHELL:

SL

LAST:

EC 2200cc

LAST	102	104	106
SIZE	25.5	26.5	27.5

COLOR:

Trsp./Pearl

CUBE3 8 MYA



LINER:

- Women's Comfort quick entry liner
- Sport frame footbed
- 35mm velcro strap

BUCKLES:

- 2 micro-adjustable plastic buckles
- 1 micro-adjustable wide-body alloy buckle
- 1 supermacro ratchet

FEATURES:

- Power control frame
- Integrated AutoSkiWalk

LEVEL:

Intermediate

FLEX INDEX:

60

SIZES:

230 – 235 – ... – 275

SHELL:

SL

LAST:

EC 2200cc

LAST	102	104	106
SIZE	25.5	26.5	27.5

COLORS:

White
Black

ART.N°: 603385

ART.N°: 603386



POLES



MYA WHITE

ART.N°: 381603

COLOR:

White/Pink

DIAMETER Ø:

16 mm

LENGTHS:

110 – 130 cm

FEATURES:

- High end women's pole
- 7075 Aluminum
- Positive angle safety thermo compact grip with chrome finish
- Lock security compact strap
- Ice steel tip
- Alpine race basket 50mm



MYA BLACK

ART.N°: 381673

COLOR:

Black/Silver/White

DIAMETER Ø:

16 mm

LENGTHS:

105 – 125 cm

FEATURES:

- Women specific SBS soft handle
- Automatic strap
- 5086 Aluminum
- Race basket
- Star tip

HELMETS

CARMA

Our CARMA features cutting-edge technology and maximum protection thanks to its HYBRID SHELL and CONEHEAD SANDWICH CORE. The adjustable 2-zone ventilation, the 3D-FIT SYSTEM, the specially designed women's beanie liner, and the height-adaptable earpieces all provide the highest possible levels of comfort and customisability.

FEATURES:

- Durable and lightweight hybrid shell construction
- Perfect shock absorption with CONEHEAD SANDWICH CORE
- Adjustable dual zone ventilation
- Height adjustable earpads
- Twist stop goggle retainer
- 3D-Fit system
- Integrated liner windshield
- Removable brim
- Women specific beanie liner

SIZES AND WEIGHTS:

XS/S	M/L
495g	540g

COLORS:

White	ART.N°: 325013
Sky	ART.N°: 325023



GRACE

The GRACE model shines with timelessly elegant colours and select materials. This helmet impresses with technical features like size-adjustability, adjustable ventilation and HEAD's patented height-adaptable earpieces.

FEATURES:

- Adjustable ventilation
- Height adjustable earpads
- Twist stop goggle retainer
- 2D-Fit system
- Integrated liner windshield
- Women specific beanie liner

SIZES AND WEIGHTS:

XS/S	M/L
375g	395g

COLORS:

Black	ART.N°: 325113
White	ART.N°: 325123



HELMET TECHNOLOGY | RESPIRO CORE

RESPIRO CORE

Our new RESPIRO core is used in the helmets of the STIVOT and VENTOR series. This EPS foam core is perforated throughout and this construction ensures a pleasantly ventilated microclimate inside the helmet, coupled with a low weight.

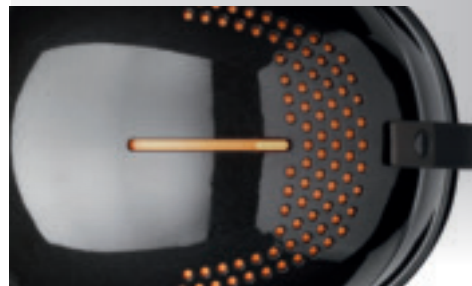
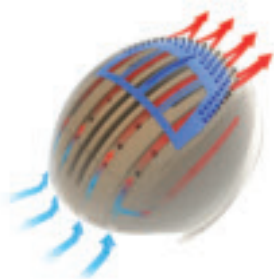

STIVOT AIR

Our current STIVOT AIR WMN helmet combines timelessly classic style, high-grade materials and stylish colours into one of the best ways to protect your head in the coming winter. Adjustable ventilation and a size adjustment system ensure a perfect fit and a cool head.

FEATURES:

- Adjustable ventilation
- 2D-Fit system
- Goggle retainer
- Women specific beanie liner

SIZES AND WEIGHTS:

XS/S	M/L
520 g	568 g

COLORS:

White	ART.N°: 322503
Berry	ART.N°: 322513



White

Berry

WOMEN

TIKA

Our TIKA is a real lightweight, designed for the fashion-conscious, dynamic sportswoman concerned with safety and style. TIKA impresses with its technical features: height-adaptable earpieces, size adjustment system and our tried and tested BEANIE LINER with folding WINDSHIELD.

FEATURES:

- Height adjustable earpads
- Twist stop goggle retainer
- 2D-Fit system
- Integrated liner windshield
- Women specific beanie liner

SIZES AND WEIGHTS:

XS/S	M/L
375 g	395 g

COLORS:

Chalk	ART.N°: 325313
Ocean	ART.N°: 325323



Chalk

Ocean

HELMETS

ELA

Light, comfortable and secure – ELA easily fulfils the basic requirements of a modern freestyle helmet. Fitted specifically to the female head shape, size-adjustable and including a built-in WINDSHIELD that bridges the gap between goggle and helmet!

FEATURES:

- Thermal ventilation
- Removable earpads
- 2D-Fit system
- Integrated liner windshield
- Women specific beanie liner

SIZES AND WEIGHTS:

XS/S	M/L
385 g	400 g

COLORS:

White	ART.N°: 325413
Mint	ART.N°: 325423



CLOE

Shining bright! CLOE makes sure you look good on the slopes. Glossy finish in a timelessly elegant white design, or bright colours – CLOE can do both. A BEANIE LINER and FIT SYSTEM ensure a perfect fit and maximum comfort.

FEATURES:

- Thermal ventilation
- Removable earpads
- 2D-Fit system
- Removable beanie liner
- Women specific beanie liner

SIZES AND WEIGHTS:

XS/S	M/L
385 g	400 g

COLORS:

White	ART.N°: 325613
Black	ART.N°: 325623
Yellow	ART.N°: 325633



PROTECTION

FLEXOR WMN VEST

The FLEXOR WMN VEST is the ideal accessory for the fashion-conscious woman who values safety and comfort. The 4-way-stretch thermo-fleece jacket is equipped with a removable viscoelastic foam protector, which complies with CE EN 1621-2 shock absorption requirements.

ART.N°: 395613

FEATURES:

- Perfectly dampening and highly energy absorbing with SAS TEC viscoelastic foam
- Antibacterial and odor-freeness life guarantee with Polygiene®
- Removable protection unit
- 4-way stretch fleece material



SIZES:

XS – L



Front



Back

BAGS

WOMEN'S TRAVELBAG

ART.N°: 383803

FEATURES:

- Women-specific wheelee bag with telescope handle for easy pulling
- Whole bag faux leather
- Large zippered main compartment and various inner and outer compartments

- Metal HEAD inlay
- Red embroidery and lining
- Rivets on front

DIMENSIONS:

64x37x32cm

VOLUME:

80l



WOMEN'S SKIBAG

ART.N°: 383813

FEATURES:

- A women-specific skibag for one pair of skis
- Comfortable carrying straps and solid compression straps
- Metal HEAD inlay
- Red embroidery and lining
- Rivets on front

DIMENSIONS:

176x24x12cm

VOLUME:

58l



WOMEN'S BOOT BAG

ART.N°: 383833

FEATURES:

- Boot bag for one pair of boots
- Ergonomic shoulder strap
- Zippered main and external compartment
- Metal HEAD inlay
- Red embroidery and lining
- Rivets on front

DIMENSIONS:

40x38x27cm

VOLUME:

37l



APPAREL

PROTECTION T-SHIRT WOMEN

ART.N°: 378853

SIZES:

S, M, L



DCT T-SHIRT WOMEN

ART.N°: 378843

SIZES:

S, M, L



LOGO T-SHIRT WOMEN

ART.N°: 378853

SIZES:

S, M, L



PROTECTION HOODY WOMEN

ART.N°: 378823

SIZES:

S, M, L



HOODY WOMEN

ART.N°: 378823

SIZES:

S, M, L



DENIM SHIRT WOMEN

ART.N°: 378833

SIZES:

S, M, L



HEADBAND WOMEN

ART.N°: 378963

SIZES:

One size



BEANIE BLUE WOMEN

ART.N°: 378933

SIZES:

One size





JUNIOR

**WHEN YOU MATCH TALENT
WITH TENACITY.
WHEN YOUR STRIDE GROWS
WITH EVERY STEP.
WHEN A DAY WITHOUT
PROGRESS IS A DAY LOST.
WHAT'S YOUR LIMIT?**

No matter how tall you are, you can be great. And like Grandpa said, a trick a day keeps boredom away. Note that the world is yours for the taking. So take your friends with you, laugh at every chance you get, and then take that, too. You'll only regret what you didn't do.

**KEEP YOUR FEET ON THE GROUND, EVEN WHEN YOUR HEAD IS
UPSIDE DOWN IN THE CLOUDS. AND EVERY DAY OF YOUR YOUNG
LIFE, SKI LIKE THERE'S NO TOMORROW.**

SKI TECHNOLOGY | JUNIOR



ERA 2.0

THE LITTLE BROTHER OF ERA 3.0.

It is everything ERA 3.0 has to offer as far as design, performance and geometry integration, but without the addition of "Rebound" with its piezoelectric Intellifibers. While we do want to see kids experience skiing performance at the highest level, they should have the best possible tools to learn and perform.

ETHAN TOO

With inspiration from both Park as well as the Big Mountain skis, this cross over utilizes the same geometric influence as the Cyclic 115 and the Caddy. The combination creates a versatile ski for the junior skier that needs to be ready to ski anything, on any day. Powder all day ever day would be the ultimate dream, but this ski makes the trip back to the base lift feel like the powder never stops.

Well equipped with both TTS as well as TNT Rocker, this twin tip features sandwich construction, highly transparent UHM bases, Tuffwall sidewalls, and a combination of progressive designs taken from The Flight Series as well as the Freestyle skis for the future of skiing.

BINDING TECHNOLOGY | SX JUNIOR/SX KID

SX JUNIOR/SX KID TECHNOLOGY

ONLY THE BEST KINEMATICS ARE GOOD ENOUGH FOR OUR JUNIOR SEGMENT.

Aspiring juniors are the future of our sport. This is reason enough to give them the full benefit of state-of-the-art safety and performance features. The 2013/14 SX JUNIOR and SX KID bindings were developed from the ground up to integrate the performance of HEAD kinematics – the leading technology that made our LX and SX bindings so successful. The SX Junior and SX Kid line is available in two designs for DIN 4.5 and DIN 7.5 models.

CENTERED STANCE ON SKI DUE TO FASTER RECENTERING

More power is directed to the ski which enables ski steering with even less effort. Thus, the risk of injuries and accidents is greatly reduced.

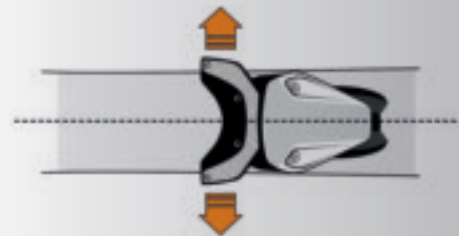

SCRATCH RESISTANCE

The majority of our SX junior models are not coated. Colored plastics are used accordingly, to guarantee increased durability and scratch-resistant bindings.

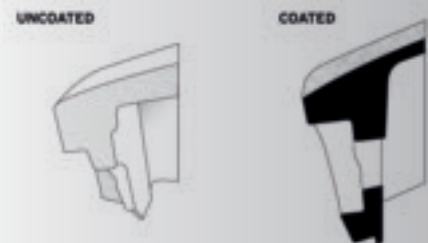

MECHANICAL ANTI FRICTION SLIDER (AFS)

The innovative mechanical AFS Junior automatically adjusts to the boot sole height, compensating A/C standards as well as height differences due to icing up, dirt or boot wear. The lateral movement of the AFS allows the boot to shift out of the binding with practically no additional friction, assuring constant release values.





WORLDCUP REBELS i.SG RD

FEATURES:



- KERS
- Intelligence Technology
- WC sandwich construction
- RD racing top sheet
- Race structured high speed UHM C base
- Rebel Camber
- FIS approved

SPECS:

Art.N°	Length	Dimensions	Radius
319943	200	99/68/87	34,6
319953	192	98/66/85	31,8
319963	182	96/66/85	28,0
319973	175	93/65/82	27,0

PLATES:

Lengths 192, 182 and 175 come with Raceplate Junior;
Length 200 comes with Race Plate RDX

BINDINGS:

ART.N°: 100503 Freeflex Pro 16 X RD



WORLDCUP GS TEAM

ART.N°: 314013

FEATURES:



- Intelligence Technology
- WC sandwich construction
- RD racing top sheet
- Race structured UHM C base

LENGTHS:

123/130/137/144/151/158/165/172

DIMENSIONS:

99/64/86 @ length 144

RADIUS:

14,2 @ length 144

SKILLS:

Level ■ ■ ■ Speed ■ ■ ■

PLATES:

Raceplate Junior

BINDINGS:

ART.N°: 100510 Freeflex Pro 11



WORLDCUP SL TEAM

ART.N°: 314023

FEATURES:



- Intelligence Technology
- WC sandwich construction
- RD racing top sheet
- Race structured UHM C base

LENGTHS:

121/131/136/141/146/151/156

DIMENSIONS:

110/63/96 @ length 141

RADIUS:

10,3 @ length 141

SKILLS:

Level ■ ■ ■ Speed ■ ■ ■

PLATES:

Raceplate Junior

BINDINGS:

ART.N°: 100510 Freeflex Pro 11



WORLD CUP i.RACE

ART.N°: 314103

FEATURES:



- Intelligence Technology
- WC sandwich construction
- UHM C base
- Structured surface

LENGTHS:

100/110/120/130/140/150/160

DIMENSIONS:

111/67/95 @ length 140

RADIUS:

10,8 @ length 140

SKILLS:

Level ■ ■ ■ Speed ■ ■ ■

BINDINGS:

ART.N°: 100547 SX9 JR Race



SUPERSHAPE LR

ART.N°: 314123

FEATURES:



- Woodcore cap construction
- Structured surface
- UHM C base

LENGTHS:

120/130/140/150/160

DIMENSIONS:

112/65/96 @ length 140

RADIUS:

9,7 @ length 140

SKILLS:

Level ■ ■ ■ Speed ■ ■ ■

PLATES:

LiteRail

BINDINGS:

ART.N°: 100436 LRX 7.5 AC



SUPERSHAPE TEAM LR

ART.N°: 312393

FEATURES:



- Jr. Power Frame
- ERA 2.0
- E base black
- Structured surface
- Also available without LiteRail from length 67 to 157 (ART.N°: 312383)
- Also available in red: (ART.N°: 314163) (without LiteRail: ART.N°: 314153)

LENGTHS:

87/97/107/117/127/137/147/157

DIMENSIONS:

111/67/96 @ length 127

RADIUS:

8,0 @ length 127

SKILLS:

Level ■ ■ ■ Speed ■ ■ ■

PLATES:

LiteRail

BINDINGS:

ART.N°: 100436 LRX 7.5 AC



MYA NO. 1 LR

ART.N°: 314263

FEATURES:



- ERA 2.0
- Jr. Power Frame
- E base black
- Also available without LiteRail from length 67 to 137 (ART.N°: 314273)

LENGTHS:

87/97/107/117/127/137

DIMENSIONS:

111/67/96 @ length 127

RADIUS:

8,0 @ length 127

SKILLS:

Level Speed

PLATES:

LiteRail

BINDINGS:

ART.N°: 100441 LRX 4.5 AC

PEZ TEAM LR

ART.N°: 314313

FEATURES:



- Jr. Power Frame
- E base black
- ERA 2.0
- Comes with PEZ candy dispenser
- Lengths 67 and 77 come without LiteRail

LENGTHS:

67/77/87/97/107/117/127/137

DIMENSIONS:

111/67/96 @ length 127

RADIUS:

8,0 @ length 127

SKILLS:

Level Speed

PLATES:

LiteRail

BINDINGS:

ART.N°: 100441 LRX 4.5 AC



BOOTS

RAPTOR B5 RD

ART.N°: 603600



LINER:

- Jr. HeatFit Pro liner
- HP frame footbed
- 40mm velcro strap

BUCKLES:

- 4 micro-adjustable Spine-Tech alloy buckles

FEATURES:

- Jr. Racing flex tuning
- Junior cuff
- Double canting
- Approved sole thickness
- Adult norm

LEVEL:

Professional

FLEX INDEX:

110/100

SIZES:

220 – 225 – ... – 285

SHELL:

PU

LAST:

RD 1500 cc

LAST	91	93	95
SIZE	25.5	26.5	27.5

COLOR:

White



RAPTOR 90 RS

ART.N°: 603610

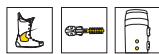

LINER:

- Jr. HeatFit Pro liner
- HP frame footbed
- 40mm velcro strap

BUCKLES:

- 4 micro-adjustable Spine-Tech alloy buckles

FEATURES:

- Jr. Racing flex tuning
- Junior cuff
- Double canting
- Approved sole thickness
- Adult norm

LEVEL:

Professional

FLEX INDEX:

90/80

SIZES:

220 – 225 – ... – 285

SHELL:

PU

LAST:

RD 1500 cc

LAST	91	93	95
SIZE	25.5	26.5	27.5

COLOR:

White

BOOTS

RAPTOR 70

ART.N°: 603615



LINER:

- Junior Team liner
- Self-shaping footbed
- 30mm velcro strap

BUCKLES:

- 4 micro-adjustable Spine-Tech alloy buckles

FEATURES:

- Jr. Racing flex tuning
- Adult norm (from size 220)

LEVEL:

Expert

FLEX INDEX:

70/60

SIZES:

200 – 210 – 220 – ... – 275

SHELL:

SL

LAST:

JR Racing

COLOR:

White



RAPTOR 50

ART.N°: 603624



LINER:

- Junior Team liner
- Self-shaping footbed
- 30mm velcro strap

BUCKLES:

- 4 plastic buckles

FEATURES:

- Jr. Racing flex tuning
- Adult norm (from size 220)

LEVEL:

Advanced

FLEX INDEX:

50

SIZES:

200 – 210 – 220 – ... – 275

SHELL:

SL

LAST:

JR Racing

COLOR:

White

RAPTOR 40

ART.N°: 603627



LINER:

- Junior Team liner
- Self-shaping footbed
- 30mm velcro strap

BUCKLES:

- 4 plastic buckles

FEATURES:

- Jr Racing flex tuning
- Adult norm (from size 220)

LEVEL:

Advanced

FLEX INDEX:

40

SIZES:

185 – 190 – ... – 275

SHELL:

SL

LAST:

JR Racing

COLOR:

White



POLES



WC SG JUNIOR

ART.N°: 381323

COLOR:

White/Black/Yellow

DIAMETER Ø:

16 mm

LENGTHS:

90 – 110 cm

FEATURES:

- Original bent JR WC racing pole
- 5086 Aluminum
- Soft downhill grip
- Buckle strap
- DH and SG cone basket yellow 40 mm
- Steel tip



SUPERSHAPE TEAM

ART.N°: 381373

COLOR:

Yellow/Black/Red

DIAMETER Ø:

14 mm

LENGTHS:

70 – 110 cm

FEATURES:

- Kids' plastic grip
- Buckle strap kids
- 5086 Aluminum
- Alpine race basket 50 mm
- Steel tip

HELMETS

STIVOT RACE YOUTH

The apple doesn't fall far from the tree. An aerodynamic shape, optimised to reduce disruptive wind noise, as well as compliance with the highest safety standards, are all features our current youth racing helmet has inherited from the STIVOT RACE.

FEATURES:

- DH/SG Racing Helmet
- Beanie liner
- Chinguard compatible

SIZES AND WEIGHTS:

XS/S	M/L
545g	610g

COLORS:

White	ART.N°: 323303
Lime	ART.N°: 323313



SLALOM RACING CHINGUARD

ART.N°: 376103

FEATURES:

- Compatible with all STIVOT RACE helmets

SIZES:

XS/S, M/L



GOGGLES

STIVOT YOUTH GOGGLE

The polycarbonate double lens ensures perfect visibility in all weather conditions. It's design and fit make these goggles the ideal accompaniment to the STIVOT RACE YOUTH helmet.

FEATURES:

- Sprayed polycarbonate lens for maximum safety
- UV 400 protection & anti-fog double lens
- Dual-density face foam
- Silicon layer

COLORS:

White	ART.N°: 373213
Lime	ART.N°: 373223





PROTECTION

FLEXOR JR UNIT RACE

Our FLEXOR JR UNIT RACE'S new shape affords greater freedom of movement in the shoulder area while keeping the same high level of impact protection. The removable shoulder straps also make this racing-design back protector FIS compliant.

ART.N°: 395823

FEATURES:

- Perfectly dampening and highly energy absorbing with SAS TEC viscoelastic foam
- Antibacterial and odor-freeness live guarantee with Polygiene®
- Removable protection unit
- FIS compatible with removable shoulder straps
- Height adjustable trouser connector straps



Polygiene®

SIZES:

116, 128, 134, 152, 164



Front



Back

APPAREL

ALL MATERIALS: 82% Polyester, 14% Elasthan, 4% Polyurethan

RACING JR SOFTSHELL JACKET

ART.N°: 829603

FEATURES:

- 2 side pockets
- Chest pocket
- 10.000 mm water column
- 10.000g/m²/24h breathability

COLOR:

Black/White/Race yellow

SIZES:

128 – 164



RACING JR SOFTSHELL VEST

ART.N°: 829613

FEATURES:

- 2 side pockets
- Chest pocket
- 10.000 mm water column
- 10.000g/m²/24h breathability

COLOR:

Black/White/Race yellow

SIZES:

128 – 164



RACING JR SOFTSHELL SHORTS

ART.N°: 829623

FEATURES:

- Protective pads
- 10.000 mm water column,
- 10.000 g/m²/24h breathability

COLOR:

Black/White/Race yellow

SIZES:

128 – 164



RACING JR SUIT

ART.N°: 829633

FEATURES:

- Full side zip
- Waist adjustment
- Detachable suspenders
- 2 side pockets
- 10.000 mm water column
- 10.000g/m²/24h breathability

COLOR:

Black/White/Race yellow

SIZES:

128 – 164



ETHAN TOO

ART.N°: 314083

FEATURES:



- Sandwich cap construction
- Highly transparent UHM base
- Tuffwalls
- ISS-Independent Suspension System
- TNT Rocker
- TTS

LENGTHS:

141/151/161/171

DIMENSIONS:

137/93/123 @ length 161

RADIUS:

12,3 @ length 161

SKILLS:

Level IIII Speed IIII

BINDINGS:

ART.N°: 111624 Peak 11 wide 90

THE JR CADDY

ART.N°: 314053

FEATURES:



- Sandwich twintip construction
- Highly transparent UHM base
- Tuffwalls
- PNP Rocker

LENGTHS:

131/141/151/161

DIMENSIONS:

116/81/106 @ length 141

RADIUS:

11,8 @ length 141

SKILLS:

Level IIII Speed IIII

BINDINGS:

ART.N°: 111627 Peak 7.5 AC wide 90





RESIDUE

ART.N°: 314173

FEATURES:



- Twintip construction
- Highly transparent UHM base
- Structured surface
- PNP Rocker

LENGTHS:

118/127/136/145/154

DIMENSIONS:

109/77/103 @ length 145

RADIUS:

13,4 @ length 145

SKILLS:

Level Speed

BINDINGS:

ART.N°: 111627 Peak 7.5 AC wide 90



BIG HEIR

ART.N°: 314213

FEATURES:



- AIRCOAT superlight twintip construction
- Highly transparent UHM base
- Structured surface
- PNP Rocker

LENGTHS:

133/142/151/160

DIMENSIONS:

109/74/98 @ length 142

RADIUS:

12,5 @ length 142

SKILLS:

Level Speed

BINDINGS:

ART.N°: 111627 Peak 7.5 AC wide 90



SOUPHEAD LR

ART.N°: 314343

FEATURES:



- Twintip construction
- E base black
- Structured surface
- Also available withouth LiteRail (ART.N°: 314333)

LENGTHS:

87/97/107/117/127/137

DIMENSIONS:

104/68/92 @ length 127

RADIUS:

9,4 @ length 127

SKILLS:

Level Speed

PLATES:

LiteRail

BINDINGS:

ART.N°: 100441 LRX 4.5 AC

BOOTS

RAPTOR CADDY JR 50

ART.N°: 603620



LINER:

- Junior Team liner
- Self-shaping footbed
- 40mm velcro strap

BUCKLES:

- 4 plastic buckles

FEATURES:

- Jr. Racing flex tuning
- Adult norm (from size 220)

LEVEL:

Advanced

FLEX INDEX:

50

SIZES:

200 – 210 – 220 – ... – 275

SHELL:

SL

LAST:

JR Racing

COLOR:

Black/White



RAPTOR CADDY JR 40

ART.N°: 603626

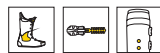

LINER:

- Junior Team liner
- Self-shaping footbed

BUCKLES:

- 3 plastic buckles

FEATURES:

- Jr. Racing flex tuning
- Adult norm (from size 220)

LEVEL:

Advanced

FLEX INDEX:

40

SIZES:

185 – 190 – ... – 245

SHELL:

SL

LAST:

JR Racing

COLOR:

Black/White

POLES



AERO TEAM

ART.N°: 381363

COLOR:

Sublimated

DIAMETER Ø:

14 mm

LENGTHS:

70 – 110cm

FEATURES:

- Kids' plastic grip
- Buckle strap kids
- 5086 Aluminum
- Alpine race basket 50mm
- Steel tip

MYA GIRL

ART.N°: 381613

COLOR:

White/Pink/Blue

DIAMETER Ø:

14 mm

LENGTHS:

70 – 110cm

FEATURES:

- Kids' plastic grip
- Buckle strap kids
- 5086 Aluminum
- Alpine race basket 50mm
- Steel tip

HELMETS

STIVOT YOUTH

Taking it's lead from the STIVOT line, our children's model STIVOT YOUTH has a clean, calm and classic appearance.

FEATURES:

- Thermal ventilation
- 2D-Fit system
- Goggle retainer
- Removable beanie liner

SIZES AND WEIGHTS:

XS/S	M/L
515g	565g

COLORS:

Blue	ART.N°: 323703
Pink	ART.N°: 323713



Blue

Pink

PROTECTION

FLEXOR JR VEST

The FLEXOR JR VEST offers not only a perfectly fitting soft protector, but also a high-grade 4-way-stretch thermo fleece and a perfect fit provided by the built-in wide waist strap. The fabric of the jacket, treated with POLYGIENE, guarantees permanent anti-bacterial qualities.

ART.N°: 395713

FEATURES:

- Perfectly dampening and highly energy absorbing with SAS TEC viscoelastic foam
- Antibacterial and odor-freeness life guarantee with Polygiene
- Removable protection unit
- 4-way stretch fleece material



Polygiene®

SIZES:

116 - 164



Front



Back

FLEXOR JR UNIT

The JUNIOR UNIT boasts customisability thanks to the waist belt and size-adjustable SHOULDER and CONNECTOR STRAPS on the one hand, and maximum comfort and ultimate protection on the other. The removable SHOULDER STRAPS ensure that the UNIT is FIS compliant.

ART.N°: 395813

FEATURES:

- Perfectly dampening and highly energy absorbing with SAS TEC viscoelastic foam
- Antibacterial and odor-freeness live guarantee with Polygiene
- Removable Protection Unit
- FIS compatible with removable shoulder straps
- Height adjustable trouser connector straps



Polygiene®

SIZES:

116 - 164



Front



Back

BOOTS

EDGE J3



LINER:

- Junior liner
- Tongue handle
- Comfort footbed

BUCKLES:

- 3 plastic buckles

FEATURES:

- Easy Entry shell construction
- SoftWalk heel
- Adult norm

LEVEL:

Intermediate

SIZES:

230 – 235 – ... – 265

SHELL:

SL

LAST:

Junior

COLORS:

Black/White **ART.N°: 603650**
Red/White **ART.N°: 603652**



EDGE J2



LINER:

- Junior liner
- Tongue handle
- Comfort footbed

BUCKLES:

- 2 plastic buckles

FEATURES:

- Easy Entry shell construction
- Kids' SkiWalk
- Junior norm
- "Design your boot" stickers

LEVEL:

Beginner

SIZES:

195 – 205 – 215 – 225

SHELL:

SL

LAST:

Junior

COLORS:

Black/White **ART.N°: 603670**
Red/White **ART.N°: 603672**

EDGE J1



LINER:

- Junior liner
- Tongue handle
- Comfort footbed

BUCKLES:

- 1 plastic buckle

FEATURES:

- Easy Entry shell construction
- Kids' SkiWalk
- Junior norm
- "Design your boot" stickers

LEVEL:

Beginner

SIZES:

155 – 165 – 175 – 185

SHELL:

SL

LAST:

Junior

COLORS:

Black/White **ART.N°: 603690**
Red/White **ART.N°: 603692**



BOOTS

SOUPHEAD 2

ART.N°: 603671



LINER:

- Junior liner
- Tongue handle
- Comfort footbed

BUCKLES:

- 2 plastic buckles

FEATURES:

- Easy Entry shell construction
- Kids' SkiWalk
- Junior norm
- "Design your boot" stickers

LEVEL:

Beginner

SIZES:

195 – 205 – 215 – 225

SHELL:

SL

LAST:

Junior

COLOR:

White



SOUPHEAD 1

ART.N°: 603691



LINER:

- Junior liner
- Tongue handle
- Comfort footbed

BUCKLES:

- 1 plastic buckle

FEATURES:

- Easy Entry shell construction
- Kids' SkiWalk
- Junior norm
- "Design your boot" stickers

LEVEL:

Beginner

SIZES:

155 – 165 – 175 – 185

SHELL:

SL

LAST:

Junior

COLOR:

White

HELMETS

JOKER

JOKER and STAR were specially developed for children. Both models boast a winning youthful design and high-grade materials. Equipped with THERMAL VENTILATION, size adjustment system and removable earpieces, these children's helmets are on a level with our adult models.

FEATURES:

- Thermal ventilation
- 2D-Fit system
- Goggle retainer
- Removable earpads

SIZES AND WEIGHTS:

XXS/XS	S/M
345g	350g

COLORS:

Black	ART.N°: 328613
White	ART.N°: 328623



STAR

FEATURES:

- Thermal ventilation
- 2D-Fit system
- Goggle retainer
- Removable earpads

SIZES AND WEIGHTS:

XXS/XS	S/M
345g	350g

COLORS:

Flamingo	ART.N°: 328713
Bluebird	ART.N°: 328723



GOGGLES

NINJA

The polycarbonate double lens with UV 400 protection provides maximum functionality and visibility. The NINJA's design was developed in coordination with our children's helmets JOKER and STAR.

FEATURES:

- Double-layer foam
- Sprayed polycarbonate double lens for maximum safety
- UV 400 protection
- Anti-fog

COLORS:

Black	ART.N°: 374712
Flamingo	ART.N°: 374722





RENTAL

**WHEN THE ONLY TOOLS
YOU NEED ARE YOUR BARE
HANDS. WHEN YOU HAVE
EVERYBODY'S FAVOURITE
SKI IN STOCK. WHEN YOUR
CUSTOMER IS GONE IN 60
SECONDS.
WHAT'S YOUR LIMIT?**

To buy or not to buy isn't the question: When rental gear performs to World Cup standards and looks like an art gallery – when a rental system minimizes your resources and maximizes both your customers' satisfaction and your re-sale value –

WHEN RENTAL HELPS TO LOWER THE BARRIER OF ENTRY TO THE SPORT AND RAISES THE FREQUENCY OF PEOPLE SKIING, THE BRAVE NEW WORLD OF RENTAL IS NOT A THREAT, BUT A BIG OPPORTUNITY.

HEAD IS FOCUSED

HEAD IS FOCUSED ON PROVIDING THE BEST RENTAL SOLUTION FOR YOUR BUSINESS. WE WILL DRIVE GROWTH FOR YOUR REVENUES, MAXIMIZE YOUR ROI, AND IMPROVE GUEST SATISFACTION.

Always in the forefront, HEAD revolutionized ski rental operations in 2006 with the BYS Rental System to deliver significant time and revenue savings for high volume rental operators and for **2013-14 HEAD CONTINUES THE EVOLUTION IN THE RENTAL BUSINESS, WITH A NEW LIGHT WEIGHT COMPOSITE CORE SKI CONSTRUCTION, A BRAND NEW ERA 2.0 CHILDREN'S SKI AND INTRODUCING THE REVOLUTIONARY 4D SNOWBOARD RENTAL SYSTEM.**

Partnering with HEAD will allow you to improve your bottom line and convert more first-time customers into life-long skiers.



THREE PART GUEST RENTAL EXPERIENCE

1 | SPEED

With the HEAD BYS System for adults and kids, along with the revolutionary 4D Snowboard RENTAL System, you can reduce your rental process time by as much as half and get your guests out riding the slopes faster than ever before.

2 | EFFICIENCY

HEAD BYS skis and HEAD rental snowboards are packed with design innovations that make your rental shop as efficient as possible. From optimized size and shape variations to visibly clear size markings, our gear is built for a fast and efficient process. Our winning rental combination is its blend of innovations, a proprietary fleet calculator, and our expert shop layout and setup help.

3 | COMFORT & PERFORMANCE

From our easy to turn, easy to learn “ERA 3.0” rental skis, 4D Snowboard RENTAL System and “Sanitize. Dock & Dry.” (SD+D) helmets, the HEAD line of rental equipment offers “conformance” for all levels of skiers and riders. To enhance the on-snow experience, we build our gear as lightweight and durable as possible.

HEAD RENTAL SOLUTIONS HELP YOUR BUSINESS BY:

- Improving your market share through targeted marketing and bringing more renters and beginners to your door.
- Reducing your costs through implementing a well-designed rental system and streamlined shop organization.
- Reducing your ski and snowboard purchases by optimizing the mix and the size curve.
- Discussing how preset DIN settings, better training, and rental-specific support is a plus for your risk management.
- Improving the satisfaction of your guests, who spend less time in your shops, feel good about their day on the hill and want to come back again.

LET US SHOW YOU HOW TO MAXIMIZE THE ROI BY INVESTING IN A HEAD RENTAL SOLUTION.

ERA 2.0

ERA 2.0 is everything ERA 3.0 has to offer as far as design, performance and geometry integration, but without the addition of “Rebound” with its piezoelectric Intellifibers. Created to deliver superior steering, increased floatation and tremendous turning radius. The best possible tools to learn and perform.

⊕ EFFORTLESS STEERING

⊕ SOFT SNOW VERSATILITY

20% ROCKER, 80% CAMBER

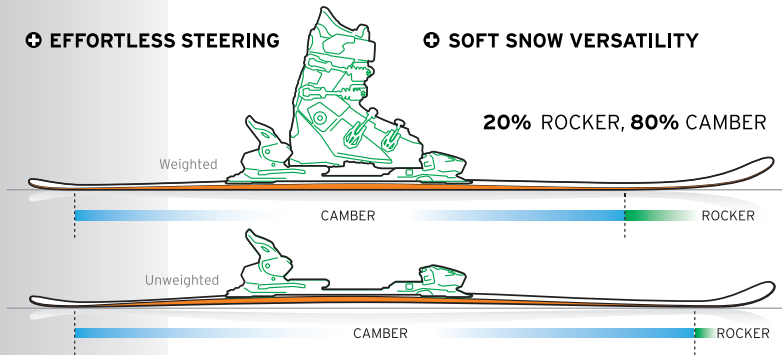

1 | ALLRIDE ROCKER

FOR SUPERIOR STEERING AND INCREASED FLOATATION.

We place a highly targeted amount of rocker in each model to ensure maximum performance for all ability levels. Steering is easier for all skiers and soft snow versatility is enhanced.

⊕ INSTANT GRIP

⊕ EFFORTLESS TURNING

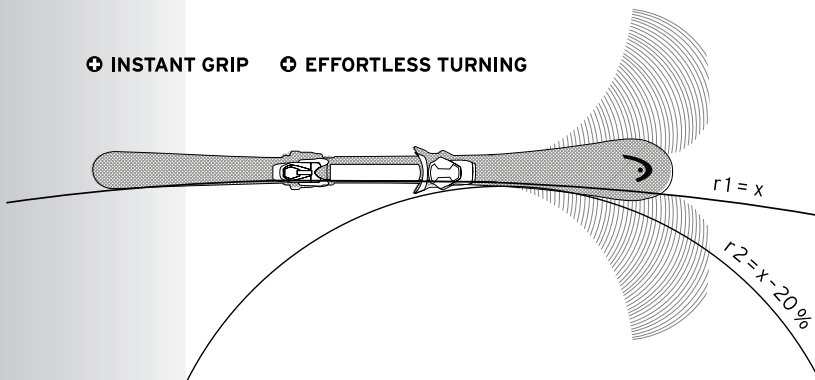

2 | PROGRESSIVE RADIUS

FOR TREMENDOUS TURNING.

Regular rocker makes skiers place their ski further on edge to have it touch from tip-to-tail. With progressive radius, up to 50% less angulation is needed to enjoy full edge contact.

MORE EDGE ON THE SNOW = MORE EDGE GRIP.



REV 80 R SW

ART.N°: 312063 Track
 ART.N°: 312083 PR
 ART.N°: 312023 Flat

FEATURES:

- ERA 3.0
- Sandwich cap construction
- ABS sidewalls
- Brushed top sheet
- Black UHM C base

LENGTHS:

142/149/156/163/170/177

DIMENSIONS:

129/80/111 @ length 170

RADIUS:

13,7 @ length 170



REV 75 R

ART.N°: 312343 Track
 ART.N°: 312373 PR
 ART.N°: 312333 Flat

FEATURES:

- ERA 3.0
- New composite core
- LizardSkin top sheet
- Black UHM C base

LENGTHS:

142/149/156/163/170/177

DIMENSIONS:

125/75/109 @ length 170

RADIUS:

13,5 @ length 170



REV 70 R

ART.N°: 312133 Track
 ART.N°: 312123 Flat

FEATURES:

- ERA 3.0
- Synthetic core construction
- SnakeSkin top sheet
- Black UHM C base

LENGTHS:

130/142/149/156/163/170

DIMENSIONS:

123/70/106 @ length 170

RADIUS:

12,8 @ length 170



INTEGRALE R 70

ART.N°: 312783 Track
ART.N°: 312763 Flat

FEATURES:

- ERA 3.0
- LizzardSkin top sheet
- Synthetic core construction
- Black UHM C base

LENGTHS:

149/156/163/170

DIMENSIONS:

125/70/109 @ length 170

RADIUS:

12,5 @ length 170



THE LINK R

ART.N°: 312813 Track
ART.N°: 312823 Black
ART.N°: 312833 Yellow
ART.N°: 312803 Flat

FEATURES:

- Early rise
- Composite radius construction
- SnakeSkin top sheet
- Synthetic core construction

LENGTHS:

130 (XS)/142 (S)/149 (M)/
163 (L)/170 (XL)

DIMENSIONS:

123/70/106 @ length 170

RADIUS:

12,8 @ length 170

COLOR CODES:



THE LINK PRO R

ART.N°: 312443 Track
ART.N°: 312453 Black
ART.N°: 312463 Yellow
ART.N°: 312433 Flat

FEATURES:

- Early rise
- Composite radius construction
- SnakeSkin top sheet
- Woodcore
- Torsion box
- Cap construction

LENGTHS:

130 (XS)/140 (S)/150 (M)/
160 (L)/170 (XL)

DIMENSIONS:

125/69/106 @ length 150

RADIUS:

10,0 @ length 150

COLOR CODES:

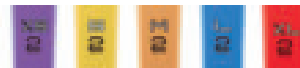



RESIDUE R TRACK

ART.N°: 312793

FEATURES:

- Heavy duty twin tip model
- Mesh top sheet
- Heavy duty woodcore
- UHM C base
- Pre-mounted rental track

LENGTHS:

118/127/136/145/154/163/172/181

DIMENSIONS:

112/79/106 @ length 172

RADIUS:

19,1 @ length 172

MYA AIR R LR

ART.N°: 312753

FEATURES:

- LizzardSkin top sheet
- New composite core construction
- LiteRail pre-mounted

LENGTHS:

142/149/156/163

DIMENSIONS:

123/74/107 @ length 156

RADIUS:

11,0 @ length 156





SUPERSHAPE TEAM R

ART.N°: 312493 Track 7,5
 ART.N°: 312483 Track 4,5
 ART.N°: 312853 Blue
 ART.N°: 312863 Black
 ART.N°: 312873 Yellow
 ART.N°: 312883 Silver
 ART.N°: 312893 Red

FEATURES:

- ERA 2.0
- SnakeSkin top sheet
- UHM C Base

SPECS:

Length	Dimensions	Radius
127	111/67/96	8,0
107	106/66/92	5,7
87	103/65/89	4,0

THE ROD

ART.N°: 312993

FEATURES:

- SnakeSkin top sheet
- Full fiber jacket
- E base black
- Pre-mounted bindings

LENGTHS:

94

DIMENSIONS:

129/90/118

RADIUS:

4,2



CARVE HT 2 B²YS

ART.N°: 607741

LINER:

- Junior rental liner
- Comfort footbed

BUCKLES:

- 2 plastic buckles

FEATURES:

- Easy Entry shell construction
- Kids' SkiWalk
- Junior norm
- 2 sole lengths
- DIN interface for all rental bindings

LEVEL:

Beginner

SIZES:

195 – 205 – 215 – 225

SHELL:

PU/SL

COLOR:

Red



CARVE HT 1 B²YS

ART.N°: 607746

LINER:

- Junior rental liner
- Comfort footbed

BUCKLES:

- 1 plastic buckle

FEATURES:

- Easy Entry shell construction
- Kids' SkiWalk
- Junior norm
- 2 sole lengths
- DIN interface for all rental bindings

LEVEL:

Beginner

SIZES:

155 – 165 – 175 – 185

SHELL:

PU/SL

COLOR:

Red

EDGE J3 HT

ART.N°: 608730

LINER:

- Junior rental liner
- Tongue handle
- Comfort footbed

BUCKLES:

- 3 plastic buckles

FEATURES:

- Easy Entry shell construction
- Adult norm
- 1 sole length
- DIN interface for all rental bindings

LEVEL:

Intermediate

SIZES:

235 – 245 – 255 – 265

SHELL:

PU/SL

COLOR:

Red



EZON 2 BYS

ART.N°: 601750

LINER:

- Comfort liner
- Sanitized® charcoal footbed
- Prepared for heating system

BUCKLES:

- 4 plastic buckles
- 1 supermacro ratchet

FEATURES:

- 3 sole lengths
- DIN interface for all rental bindings

LEVEL:

Intermediate

SIZES:

235 – 245 – ... – 265 women's constr.
270 – 275 – ... – 340 unisex constr.

SHELL:

PU/SL

COLORS:

Silver, Yellow, Black



BYS

ART.N°: 601760

LINER:

- Comfort liner
- Sanitized® charcoal footbed
- Prepared for heating system

BUCKLES:

- 3 plastic buckles
- 1 supermacro ratchet

FEATURES:

- 3 sole lengths
- DIN interface for all rental bindings

LEVEL:

Beginner

SIZES:

235 – 245 – ... – 340

SHELL:

PU/SL

COLORS:

Black, Silver, Yellow

BYS 10

FACTORY INSTALLED

FEATURES:

- SX toe with TRP system
- Full diagonal
- ABS – Anti Blocking System
- Rent heel
- Solid colored

STAND HEIGHT:

21,0mm

DIN:

2.5 – 10

WEIGHT:

1890g

WEIGHT RANGE:

From 26 kg / from 57 lbs

COLOR:

Solid Black / Anthracite



BYS 7.5

FACTORY INSTALLED

FEATURES:

- SX Junior toe with TRP system
- Full diagonal
- SX Junior heel
- Solid colored
- AFS Junior

STAND HEIGHT:

21,0mm

DIN:

2 – 7.5

WEIGHT:

1830g

WEIGHT RANGE:

From 22 – 84 kg / from 48 – 187 lbs

COLOR:

Solid Black



B²YS 4.5 AC

FACTORY INSTALLED

FEATURES:

- SX Kid toe with TRP system
- Full diagonal
- AFS Junior
- SX Kid heel
- Solid colored

STAND HEIGHT:

15,0mm

DIN:

0.75 – 4.5

WEIGHT:

1195g

WEIGHT RANGE:

From 10 – 48 kg / from 22 – 105 lbs

COLOR:

Solid Black





ADULT RENTAL

ART.N°: 381421

COLOR:

Color coded by length

DIAMETER Ø:

18x1 mm

LENGTHS:

110 – 135 cm

FEATURES:

- 7075 Aluminum
- PE grip
- Color coded design
- Color coded baskets
- Length indication cm/inch
- Steel tip

ADULT RENTAL SUBLIMATED

ART.N°: 381422

COLOR:

Color coded by length

DIAMETER Ø:

18x1 mm

LENGTHS:

110 – 135 cm

FEATURES:

- 7075 Aluminum
- PE grip
- Color coded design
- Color coded baskets
- Thermo sublimated finish
- Length indication cm/inch
- Steel tip

JUNIOR RENTAL

ART.N°: 381411

COLOR:

Color coded by length

DIAMETER Ø:

16x0,8 mm

LENGTHS:

70 – 105 cm

FEATURES:

- 7075 Aluminum
- Junior PE grip
- Color coded design
- Color coded baskets
- Length indication cm/inch
- Steel tip

JUNIOR RENTAL SUBLIMATED

ART.N°: 381412

COLOR:

Color coded by length

DIAMETER Ø:

16x0,8 mm

LENGTHS:

70 – 105 cm

FEATURES:

- 7075 Aluminum
- Junior PE grip
- Color coded design
- Color coded baskets
- Thermo sublimated finish
- Length indication cm/inch
- Steel tip



SP 130 ABS DEMO AERO

ART.N°: 111447

FEATURES:

- AERO One Touch Toe with TRP system
- Race Diagonal
- ABS – Anti Blocking System
- Rent One Touch heel
- Dura-Coating

STAND HEIGHT:

31,0mm

DIN:

4 – 13

WEIGHT:

2770g

WEIGHT RANGE:

From 42 kg/from 92 lbs

COLOR:

Solid Black/Anthracite



SP 12 ABS WIDE 97

ART.N°: 111563

FEATURES:

- LX One Touch Toe with TRP system
- Full Diagonal
- ABS – Anti Blocking System
- Rent One Touch heel
- Dura-Coating
- Wide brake 97

STAND HEIGHT:

31,0mm

DIN:

4 – 12

WEIGHT:

2600g

WEIGHT RANGE:

From 42 kg/from 92 lbs

COLOR:

Solid Black/Anthracite

SP 12 ABS W/O BRAKE

ART.N°: 111564



SP 10 ABS

ART.N°: 111565

FEATURES:

- SX One Touch Toe with TRP system
- Full Diagonal
- ABS – Anti Blocking System
- Rent One Touch heel
- Solid colored

STAND HEIGHT:

31,0mm

DIN:

2.5 – 10

WEIGHT:

2570g

WEIGHT RANGE:

From 26 kg/from 57 lbs

COLOR:

Solid Black/Anthracite

SP 10 ABS W/O BRAKE

ART.N°: 111566

SP 10 ABS PM

ART.N°: 111567



SP 7.5 AC

ART.N°: 111671

FEATURES:

- SX Junior toe with TRP system
- Full Diagonal
- AFS Junior
- SX Junior heel
- Solid colored

STAND HEIGHT:

31,0mm

DIN:

1.5 – 7.5

WEIGHT:

2450g

WEIGHT RANGE:

18 – 84 kg/39 – 187 lbs

COLOR:

Solid Black/Anthracite

SP 7.5 AC PM

ART.N°: 111670



SP 4.5 AC

ART.N°: 111571

FEATURES:

- SX Kid One Touch Toe with TRP system
- Full Diagonal
- AFS Junior
- SX Kid One Touch Heel
- Solid colored

STAND HEIGHT:

25,0mm

DIN:

0.75 – 4.5

WEIGHT:

1630g

WEIGHT RANGE:

10 – 48 kg/22 – 105 lbs

COLOR:

Solid Black

SP 4.5 AC PM

ART.N°: 111572



SR 10

ART.N°: 111573

FEATURES:

- SX Toe with TRP system
- Full Diagonal
- Teflon
- Rent One Touch heel
- Solid colored

STAND HEIGHT:

22,0mm

DIN:

2.5 – 10

WEIGHT:

1210g

WEIGHT RANGE:

From 26 kg/from 57 lbs

COLOR:

Solid Black/Anthracite



SR 4.5 AC

ART.N°: 111574

FEATURES:

- SX Kid Toe with TRP system
- Full Diagonal
- AFS Junior
- SX Kid One Touch heel
- Solid colored

STAND HEIGHT:

15,0mm

DIN:

0.75 – 4.5

WEIGHT:

1235g

WEIGHT RANGE:

10 – 48kg/22 – 105 lbs

COLOR:

Solid Black



TYROLIA PR 10

ART.N°: 111418

FEATURES:

- SX Toe with TRP system
- Full Diagonal
- AFS
- PowerRail
- SX heel
- Solid colored

STAND HEIGHT:

31,0mm

DIN:

3 – 10

WEIGHT:

1770 g

WEIGHT RANGE:

From 31 kg/from 67 lbs

COLOR:

Solid Black/Silver

TYROLIA PR 10 WIDE 90

ART.N°: 111522



TYROLIA LRX 9.0

ART.N°: 111527

FEATURES:

- SX Toe with TRP system
- Full Diagonal
- ABS – Anti Blocking System
- LiteRail
- SL Lite heel
- Solid colored

STAND HEIGHT:

28,0mm

DIN:

2.5 – 9

WEIGHT:

1600g

WEIGHT RANGE:

From 26 kg/from 57 lbs

COLOR:

Solid Black/Silver



TYROLIA LRX 7.5

ART.N°: 111535

FEATURES:

- SX Junior Toe with TRP system
- Full Diagonal
- AFS Junior
- LiteRail
- SX Junior heel
- Solid colored

STAND HEIGHT:

28,0mm

DIN:

2 – 7.5

WEIGHT:

1380g

WEIGHT RANGE:

22 – 84kg/48 – 187 lbs

COLOR:

Solid Black/Silver



TYROLIA LRX 4.5 AC

ART.N°: 111542

FEATURES:

- SX Kid Toe with TRP system
- Full Diagonal
- AFS Junior
- LiteRail
- SX Kid heel
- Solid colored

STAND HEIGHT:

28,0mm

DIN:

0.75 – 4.5

WEIGHT:

1270g

WEIGHT RANGE:

10 – 48kg/22 – 105 lbs

COLOR:

Solid Black/Silver



VECTOR 115 HT

ART.N°: 603702

LINER:

- Perfect Fit S liner
- HP frame footbed
- 40mm velcro strap

BUCKLES:

- 4 micro-adjustable alloy buckles
- 1 supermacro ratchet

FEATURES:

- Bi-Inj frame
- Easy Entry shell design
- Flex tuning
- Double canting
- Rear support tuning

LEVEL:

Expert

FLEX INDEX:

115/105

SIZES:

250 – 255 – ... – 305

SHELL:

PU

LAST:

S 2000cc

LAST SIZE	98	101	103
	25.5	26.5	27.5

COLOR:

Green/Black



ADAPTEGE 100 HT

ART.N°: 603704

LINER:

- Comfort liner
- Sport frame footbed
- 40mm velcro strap

BUCKLES:

- 4 micro-adjustable alloy buckles
- 2 Double Power levers
- 1 supermacro ratchet

FEATURES:

- Tri-Inj. energy frame
- Adaptive Fit Technology
- Easy Entry shell design
- Stiffer/softer flex adjustment
- Double canting
- Adjustable rear spoiler

LEVEL:

Advanced

FLEX INDEX:

100/90

SIZES:

230 – 235 – ... – 255 women's constr.
260 – 265 – ... – 320 unisex constr.

SHELL:

PU

LAST:

C 2100cc

LAST SIZE	100-98	102-100	104-102
	25.5	26.5	27.5

COLOR:

Trsp. Anthracite/Black

NEXTEGE 90 HT

ART.N°: 603712

LINER:

- Comfort liner
- Sanitized® charcoal footbed
- 40mm velcro strap

BUCKLES:

- 4 micro-adjustable alloy buckles
- 1 supermacro ratchet

FEATURES:

- Tri-Inj. energy frame
- Easy Entry shell design
- Stiffer/softer flex adjustment
- Double canting
- Adjustable rear spoiler

LEVEL:

Advanced

FLEX INDEX:

90/80

SIZES:

250 – 260 – 265 – ... – 305

SHELL:

PU

LAST:

S 2000cc

LAST SIZE	100	102	104
	25.5	26.5	27.5

COLOR:

Trsp. Red/White



NEXTEDGE 90 HT MYA

ART.N°: 603714

LINER:

- Women's comfort liner
- Fleece lining
- Sanitized® charcoal footbed
- 40mm velcro strap

BUCKLES:

- 4 micro-adjustable alloy buckles
- 2 Double Power levers
- 1 supermacro ratchet

FEATURES:

- Tri-Inj. energy frame
- Easy Entry shell design
- Double adjustable profile
- Stiffer/softer flex adjustment
- Double canting

LEVEL:

Advanced

FLEX INDEX:

80/70

SIZES:

220 – 230 – 235 – ... – 275

SHELL:

PU

LAST:

C 2100cc

LAST	100	102	104
SIZE	25.5	26.5	27.5

COLOR:

Trsp. Anthracite/White



NEXTEDGE 80 HT

ART.N°: 603717

LINER:

- Comfort liner
- Sanitized® charcoal footbed
- 40mm velcro strap

BUCKLES:

- 4 micro-adjustable alloy buckles
- 1 supermacro ratchet

FEATURES:

- Tri-Inj. energy frame
- Easy Entry shell design
- Double canting

LEVEL:

Advanced

FLEX INDEX:

80

SIZES:

250 – 260 – 265 – ... – 340

SHELL:

PU/SL

LAST:

C 2100cc

LAST	100	102	104
SIZE	25.5	26.5	27.5

COLOR:

Black/White

NEXTEDGE 80 HT MYA

ART.N°: 603718

LINER:

- Women's comfort liner
- Fleece lining
- Sanitized® charcoal footbed
- 40mm velcro strap

BUCKLES:

- 4 micro-adjustable alloy buckles
- 1 supermacro ratchet

FEATURES:

- Tri-Inj. energy frame
- Easy Entry shell design
- Double adjustable profile
- Double canting

LEVEL:

Advanced

FLEX INDEX:

70

SIZES:

220 – 230 – 235 – ... – 275

SHELL:

PU/SL

LAST:

C 2100cc

LAST	100	102	104
SIZE	25.5	26.5	27.5

COLOR:

White/Silver



FX 7.5

ART.N°: 602741

LINER:

- Comfort liner
- Sanitized® charcoal footbed
- 30mm velcro strap

BUCKLES:

- 4 plastic buckles
- 1 supermacro ratchet

FEATURES:

- Power control frame

LEVEL:

Intermediate

FLEX INDEX:

60

SIZES:

230 – 235 – 240 – 245 – ... – 305

SHELL:

PU/SL

LAST:

EC 2200cc

LAST	102	104	106
SIZE	25.5	26.5	27.5

COLOR:

Black/Red



CUBE3 8 HT

ART.N°: 603744

LINER:

- Comfort quick entry liner
- Sanitized® charcoal footbed
- 30mm velcro strap

BUCKLES:

- 2 micro-adjustable plastic buckles
- 1 micro-adjustable wide-body alloy buckle
- 1 supermacro ratchet

FEATURES:

- Power control frame
- Integrated AutoSkiWalk

LEVEL:

Intermediate

FLEX INDEX:

70

SIZES:

260 – 265 – ... – 305

SHELL:

PU/SL

LAST:

EC 2200cc

LAST	102	104	106
SIZE	25.5	26.5	27.5

COLOR:

Black

CUBE3 8 HT MYA

ART.N°: 603747

LINER:

- Women's comfort quick entry liner
- Sanitized® charcoal footbed
- 30mm velcro strap

BUCKLES:

- 2 micro-adjustable plastic buckles
- 1 micro-adjustable wide-body alloy buckle
- 1 supermacro ratchet

FEATURES:

- Power control frame
- Integrated AutoSkiWalk

LEVEL:

Intermediate

FLEX INDEX:

60

SIZES:

230 – 235 – ... – 275

SHELL:

PU/SL

LAST:

EC 2200cc

LAST	102	104	106
SIZE	25.5	26.5	27.5

COLOR:

Black



RR8

ART.N°: 602770

LINER:

- Comfort rear entry liner
- Sanitized® charcoal footbed

BUCKLES:

- 1 plastic buckle

FEATURES:

- Rear entry

LEVEL:

Beginner

SIZES:

235 –...– 305

SHELL:

PU/SL

COLOR:

Black/White



RAPTOR 50 HT

ART.N°: 603755

LINER:

- Junior Team liner
- Self-shaping footbed

BUCKLES:

- 4 plastic buckles

FEATURES:

- Jr Racing flex tuning
- Adult norm (from size 220)

LEVEL:

Advanced

SIZES:

200 – 210 – 220 –...– 265

SHELL:

PU/SL

COLOR:

Black/White

RAPTOR 40 HT

ART.N°: 603756

LINER:

- Junior Team liner
- Self-shaping footbed

BUCKLES:

- 4 plastic buckles

FEATURES:

- Jr Racing flex tuning
- Adult norm

LEVEL:

Advanced

SIZES:

180 – 190

SHELL:

PU/SL

COLOR:

Black/White



RENTAL SD+D TECHNOLOGY | SANITIZE. DOCK & DRY

SD+D
SANITIZE. DOCK & DRY

SD+D – SANITIZE. DOCK & DRY THE FIRST FULLY-INTEGRATED RENTAL HELMET CONCEPT.

SANITIZE

From rapid drying to complete disinfection of the helmet. The optional integration of the IONIZATION TUBE prevents development of odors and kills germs and bacteria.

HEAD SANITIZER guarantees optimal helmet disinfection – quickly and efficiently.

DOCK

The HEAD SD+D system provides space for up to 108 SD+D helmets per m² of floor space. The modular construction enables optimal adaptation to the individual space and quantity requirements of every client. Extension to the system – from the simple storage solution to the fully-integrated & ventilated HELMET DRYING RACK, is possible at any time.

DRY

Via AIRDOCKS warm air is directed inside of the helmet. The result: minimal drying time for the operator and pleasantly warm helmets for the rental customer. The helmets are stored according to a logical and individually ordered system. Magnetic AIRDOCKS keep the helmets safely in position – this ensures easy and direct access.

ALL HELMETS
OF THE HEAD
VENTOR
RANGE ARE
COMPATIBLE
WITH THE
SD+D SYSTEM.



SD + D

HELMET STORAGE RACK

HEAD has the solution for efficient storage of helmets: the HELMET STORAGE RACK can be adjusted to the space and quantity requirements of the client and provides both space and easy access for up to 324 helmets on a floor space of 3 m².

HELMET STORAGE RACK 150

ART.N°: 375502 for 180 helmets

HELMET STORAGE RACK 200

ART.N°: 375512 for 252 helmets

HELMET STORAGE RACK 240

ART.N°: 375522 for 324 helmets

HELMET DRYING RACK

In addition to the advantages of the HELMET STORAGE RACK, the HELMET DRYING RACK guarantees rapid and effective drying of the helmets via an integrated drying module.

Warm air is directed inside the helmet via the AIRDOCKs and dries the helmets from the inside out, thus reducing drying time to a minimum.

The optional ionization tube integrated directly into the air intake also prevents development of odor in the helmets. Both the HELMET STORAGE RACK and the HELMET DRYING RACK are available in widths of 150 cm, 200 cm and 240 cm as free-standing racks on legs. Existing track systems of the brand MONTANA can be integrated if required.

HELMET DRYING RACK 150

ART.N°: 375532 for 180 helmets

HELMET DRYING RACK 200

ART.N°: 375542 for 252 helmets

HELMET DRYING RACK 240

ART.N°: 375552 for 324 helmets

HELMET WALLDRYER 100

ART.N°: 375532

The helmet WALLDRYER 100 completes the portfolio of the SD+D system; it can hold 60 helmets on only one meter or three feet of wall space. Helmets attached to the system can be automatically dried during storage and an ionization unit is also available as an option. Standard household power supply can be used to operate the

unit on 220V or 110V. This not only makes the smallest version of a full-feature SD+D system an easy step into the system, but it also fulfills the needs of smaller operations. The SD+D HELMET WALLDRYER 100 racks can be used free standing or standing against a wall.



SD + D

RENTAL INTERFACE

ART.N°: 375412

The starting point for the modular HEAD SD+D system. An interface offers space for space-saving and efficient storage of 3 helmets and can be used together with the FLIP CLIP RAIL, HELMET STORAGE & DRYING RACK, and HELMET WALLDRYER.



FLIP CLIP RAIL

Tracks for the simple and individual assembly of the RENTAL INTERFACE. In the 1- or 2-meter version, the FLIP CLIP RAIL offers space for 3 or 6 RENTAL INTERFACES.

LENGTH:

1 meter
2 meter

ART.N°: 375442

ART.N°: 375452



HEAD SANITIZER

ART.N°: 375462

With this easy-to-operate stainless-steel appliance you can disinfect rental shoes and helmets quickly and efficiently.

Three spray jets ensure even distribution of the disinfectant over the whole shoe or helmet for controlled sterilization thereby preventing development of odors. The included table ensures an ideal working height and practical storage space.



HELMETS | SD+D COMPATIBLE

VENTOR PRO R

Fully compatible with the HEAD SD+D system, this helmet caters to all your customers' needs when wearing a helmet. The ADJUSTABLE VENTILATION and our SIZE FIT help to customize the helmet for every weather condition and helmet size. Features like color code integration, or the integrated barcode makes rental operations more efficient. The appealing look of the VENTOR PRO R with two dynamic design options offers you the possibility, to provide your customers not only a protective item, but also a visual highlight.

FEATURES:

- Compatible with SD+D
- Adjustable ventilation
- 2D-Fit system
- Goggle retainer
- Scan-Barcode

SIZES AND WEIGHTS:

XS/S	M/L	XL/XXL
500g	550g	610g

COLORS:

Black/White	ART.N°: 329002
Lime/Blue	ART.N°: 329013



VENTOR R

Helmets have become a part of every winter sports participant's standard equipment – and hence a standard product in every rental operation. Our VENTOR series was developed to perfectly address that. The compatibility with HEAD's SD+D system allows to store these helmets in the most efficient and hygienic way. The TOUGH SHELL makes the helmet bulletproof on the outside, the RESPIRO CORE provides THERMAL VENTILATION and caters for a warm and comfortable climate on the inside.

Color codes help you identifying the right size for your customers, whereas the SIZE FIT guarantees the perfect fit when wearing it.

Two design options make it not only another rental product, but an object of desire.

FEATURES:

- Compatible with SD+D
- Adjustable ventilation
- 2D-Fit system
- Goggle retainer
- Scan-Barcode

SIZES AND WEIGHTS:

XS/S	M/L	XL/XXL
500g	550g	610g

SIZES AND WEIGHTS YOUTH:

XSS	XS/S	M/L
490g	500g	550g

COLORS ADULT:

Black	ART.N°: 329052
White	ART.N°: 329103

COLORS YOUTH:

White	ART.N°: 329702
Lime	ART.N°: 329713



HELMETS | NON SD + D COMPATIBLE

RENTAL SR

The ABS construction of this color coded helmet makes the RENTAL SR and RENTAL JR a durable and reliable helmet, built to last.

THERMAL VENTILATION conveys warm air and moist out of the helmet and guarantees a comfortable climate in the helmet. For safe and snug fit, we implemented the SIZE FIT ADJUSTER.

ART.N°: 329513

FEATURES:

- Thermal ventilation
- 2D-Fit system
- Goggle retainer
- Scan-Barcode

SIZES AND WEIGHTS:

XS/S	M/L	XL/XXL
470g	520g	570g

COLOR:

Black



Black



RENTAL JR

ART.N°: 329813

FEATURES:

- Thermal ventilation
- 2D-Fit system
- Goggle retainer
- Scan-Barcode

SIZES AND WEIGHTS:

XXS	XS/S	M/L
450g	470g	520g

COLOR:

White



White



HELMET ACCESSORIES



RENTAL BEANIE SR/JR

ART.N°: 375108 Rental Beanie SR
ART.N°: 375208 Rental Beanie JR

FEATURES:

Washable & removable beanie liner.



HELMET SIZER

ART.N°: 375812

FEATURES:

Measure the right HEAD size.

PROTECTION

FLEXOR UNIT R SR/JR

Full action needs full protection – our understanding of full protection is the combination of helmet and body protection, so we enhanced our protection portfolio with the FLEXOR series.

The soft SAS-TEC foam perfectly adapts to body shapes, so no one will even feel the protector is there. The implemented color coding system helps identifying the right products quick and easily and assures a perfect fit. The POLYGIENE treatment of the lining prevents bad odors to develop, the TOUGH SKIN outer material ensures durability.

ART.N°: 395453 Senior
ART.N°: 395463 Junior

FEATURES:

- Perfectly dampening and multi-energy absorbing with SAS TEC viscoelastic foam
- Antibacterial and odor-freeness life guarantee with Polygiene
- Removable protection unit
- Height adjustable trouser connector straps
- Rental specific durable nylon material
- Scan-barcode

SIZES:

XXS – XL/XXL



Senior | Back



Scan-barcode



Removable Protection Unit



Junior | Back



Junior | Back



Senior | Back

RENTAL SNOWBOARD TECHNOLOGY | 4DIMENSIONS

2006 WE BROUGHT YOU BYS.
2012 WE BROUGHT YOU SD+D.

2014 WE BRING YOU 4D, AND HENCE TAKE SNOWBOARD RENTALS TO THE NEXT DIMENSION.

HEAD BRINGS YOU 4D – PERFECT SETUP, MOST EFFICIENT.



We face each of our customers individually, cater to their perfect setup when renting equipment. Having a positive experience when riding is the key driver to returning customers, no matter what age, gender, ability level or family situation they are – everyone has very own specific needs, which the HEAD 4D system and its wide product portfolio

addresses. And all of that in even less time. If you had to explain the all new 4D system with one word, it would be: Efficiency. But 4D also stands for functionality, reliability and innovation: It is the first snowboard rental system with integrated color coding for boots, boards AND bindings. The all new 4D system manages it to cater for the perfect

setup for every single customer of yours, and at the same time, being the easiest, quickest & most efficient snowboard rental system on the market. Although the benefits of 4D can only be fully exploited by using 4D compatible products, each product can also be used by itself or combined with non-4D products – thanks to its modular structure.

RENTAL SNOWBOARD TECHNOLOGY | FRAMEWALL

FRAMEWALL

The extraordinary stressing of rental snowboards so far resulted in fast abrasion as far as delamination of top sheets. This problem has been solved with the all new FRAMEWALL. The three-dimensional build of the sidewall covers the boards top sheet and prevents it from chipping and other external hazards, which is resulting in delamination. The FRAMEWALL is the first 360° protector on a snowboard – that stretches the boards durability considerably!



FRAMEWALL

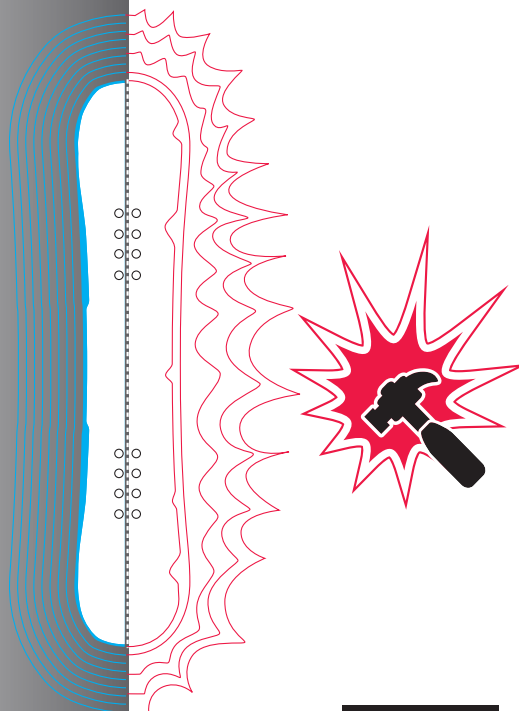

SIDEWALL

SNOWBOARDS

FLOCKA 4D

ART.N°: 337003 FLOCKA 4D+SPEEDDISC
ART.N°: 337053 FLOCKA 4D

One board to rule them all! We took the best of camber and rocker technology to create a board which helps beginners to pick up riding quickly and also supports intermediates and advanced at their next steps.

The all new FRAMEWALL gives the board its characteristic look, protects the board from impact and prevents the top sheet from chipping. Next to that, the innovative sidewall design has a dampening function and hence makes riding smoother and assures even distribution of edge-pressure. Of course, the implemented color coding adapts to the 4D system and makes the rental process quicker than ever! Not to mention the nice design...

FEATURES:

- 4D compatible
- Flocka shape
- FRAMEWALL
- Pro-Rent top sheet
- Poplar woodcore
- Control jacket
- Easy maintenance base



SPECS:

Sizes	Loaded effective edge (cm)	Waist (mm)	Med. stance (cm)
146	109,0	239	51
151	111,0	244	53
149	110,5	247	52
154	114,5	250	56
159	114,9	254	58
158	114,9	264	58
163	119,9	266	60
168	124,9	268	60

FLOCKA 4D JR

ART.N°: 337103 FLOCKA 4D JR+SPEEDDISC
ART.N°: 337153 FLOCKA 4D JR

SPECS:

Sizes	Loaded effective edge (cm)	Waist (mm)	Med. stance (cm)
120	82,6	220	42
130	92,0	230	44
140	101,0	240	46

FLOCKA 4D KID

ART.N°: 337203 FLOCKA 4D KID+SPEEDDISC
ART.N°: 337253 FLOCKA 4D KID

SPECS:

Sizes	Loaded effective edge (cm)	Waist (mm)	Med. stance (cm)
90	60,0	200	30
100	67,0	210	32
110	75,3	220	36

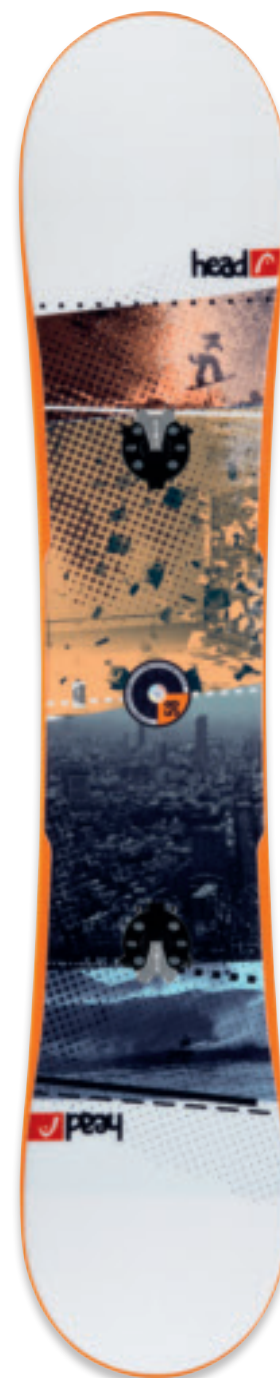

SNOWBOARDS

ROCKA PLUS 4D

ART.N°: 337313 ROCKA PLUS 4D
+SPEEDDISC

ART.N°: 337353 ROCKA PLUS 4D

Thanks to rocker technology, getting a hang of snowboarding was never easier. But not only beginners enjoy the benefits of the early rise. That shape is perfect for park and back-country as well! What we did was adding an integrated T&T protector to the board to increase durability, plus a nice design that suits the rocker style. Of course, the design adapts to our 4D system. Less time in shops, more time to play.

FEATURES:

- 4D compatible
- Rocka shape
- Integral T&T shield tip & tail protector
- Easy-Rent top sheet
- Poplar woodcore
- Cruiser jacket
- Easy maintenance base



SPECS:

Sizes	Loaded effective edge (cm)	Waist (mm)	Med. stance (cm)
146	58	237	50
151	60	243	52
149	60	244	52
154	64	250	56
159	66	253	58
158	66	264	58
163	68	266	60
168	68	268	60

ROCKA PLUS 4D JR

ART.N°: 337403 ROCKA PLUS 4D JR
+SPEEDDISC

ART.N°: 337453 ROCKA PLUS 4D JR

SPECS:

Sizes	Loaded effective edge (cm)	Waist (mm)	Med. stance (cm)
120	50	220	42
130	52	230	44
140	54	240	46

ROCKA PLUS 4D KID

ART.N°: 337503 ROCKA PLUS 4D KID
+SPEEDDISC

ART.N°: 337553 ROCKA PLUS 4D KID

SPECS:

Sizes	Loaded effective edge (cm)	Waist (mm)	Med. stance (cm)
90	38	200	30
100	40	210	32
110	44	220	36



SNOWBOARDS

ROCKA 4D

ART.N°: 337603 ROCKA 4D + SPEEDDISC

ART.N°: 337653 ROCKA 4D

Together, we bring people to ride! The rocker shape makes turning easier and hooks up beginners with their new favorite sport. Thanks to our T&T protectors, the scratch resistant EASY-RENT top sheet and the cap construction you don't have to worry about durability. Simply bulletproof.

FEATURES:

- 4D compatible
- Rocka shape
- Exchangeable tip & tail bumpers
- Easy-Rent top sheet
- Poplar woodcore
- Cruiser jacket
- Easy maintenance base



SPECS:

Sizes	Loaded effective edge (cm)	Waist (mm)	Med. stance (cm)
146	58	237	50
151	60	243	52
149	60	244	52
154	64	250	56
159	66	253	58
158	66	264	58
163	68	266	60
168	68	268	60

ROCKA 4D JR

ART.N°: 337703 ROCKA 4D JR

+ SPEEDDISC

ART.N°: 337753 ROCKA 4D JR

SPECS:

Sizes	Loaded effective edge (cm)	Waist (mm)	Med. stance (cm)
120	50	220	42
130	52	230	44
140	54	240	46

ROCKA 4D KID

ART.N°: 337803 ROCKA 4D KID

+ SPEEDDISC

ART.N°: 337853 ROCKA 4D KID

SPECS:

Sizes	Loaded effective edge (cm)	Waist (mm)	Med. stance (cm)
90	38	200	30
100	40	210	32
110	44	220	36



BINDINGS



RX 4D SPEEDDISC

RECLINING
HIGHBACK

ART.N°: 347103

FEATURES:

- 4D compatible
- Reclining highback
- Rubber dampened base
- Padded highback
- Power transmission strap
- Dura tech toe strap



SIZES:

S/M/L

NX 4D SPEEDDISC

ART.N°: 347403

FEATURES:

- 4D compatible
- AutoOpen Total
- Toe & heel base pads
- Padded highback
- Toolfree forward lean adjuster
- Power transmission strap
- Dura tech toe strap
- Alu buckles



SIZES:

S/M/L



P THREE 4D SPEEDDISC

ART.N°: 347503

FEATURES:

- 4D compatible
- Alu heelcup
- Toe & heel base pads
- Padded highback
- 3D comfort strap
- Dura tech toe strap
- Alu buckles



SIZES:

S/M/L

P 4D JR SPEEDDISC

ART.N°: 347603

FEATURES:

- 4D compatible
- JR specific construction
- Padded junior highback
- Fit ankle strap



SIZE:

JR



BOOTS

550 4D

ART.N°: 357103 550 4D
ART.N°: 357143 550 4D BOA (+COILER)

FEATURES:

- 4D compatible
- Moonwalker R Pro outsole
- Cuff cut construction
- Heel frame
- Rubber heelcup
- Rubber toecap
- Exchangeable rubber tongue guard
- Top-fit liner
- Polygiene treatment



SIZES:

250, 255, 260, 265, 270, 275,
280, 285, 290, 295, 300, 305,
315, 325

550 4D JR

ART.N°: 357203 550 4D JR
ART.N°: 357243 550 4D JR BOA (+COILER)

SIZES:

225, 235, 245

550 4D KID

ART.N°: 357303 550 4D KID
ART.N°: 357343 550 4D KID BOA
(+COILER)

SIZES:

195, 205, 215



500 4D

ART.N°: 357403 500 4D
ART.N°: 357443 500 4D BOA (+COILER)

FEATURES:

- 4D compatible
- Explorer outsole
- Rubber covered laceguides
- Injected heel section
- Rubber toecap
- Easy-fit liner
- Polygiene treatment



SIZES:

250, 255, 260, 265, 270, 275,
280, 285, 290, 295, 300, 305,
315, 325

500 4D JR

ART.N°: 357503 500 4D JR
ART.N°: 357543 500 4D JR BOA (+COILER)

SIZES:

225, 235, 245

500 4D KID

ART.N°: 357603 500 4D KID
ART.N°: 357643 500 4D KID BOA (+COILER)

SIZES:





195, 205, 215



RENTAL SNOWBOARD TECHNOLOGY | 4D COLOR CODE



PERFECT SETUP.
MOST EFFICIENT.

SIZES	BOOT			BINDING	BOARD
	MONDO 195 – 215	EU 30,5 – 33,5	US 1 – 3	JR	90 100 110 120 130 140
	MONDO 225 – 250	EU 35 – 39	US 4 – 6,5	S	146 151
	MONDO 255 – 280	EU 39,5 – 43	US 7 – 10	M	149 154 159
	MONDO 285 – 325	EU 44 – 49,5	US 10,5 – 14,5	L	158 163 168

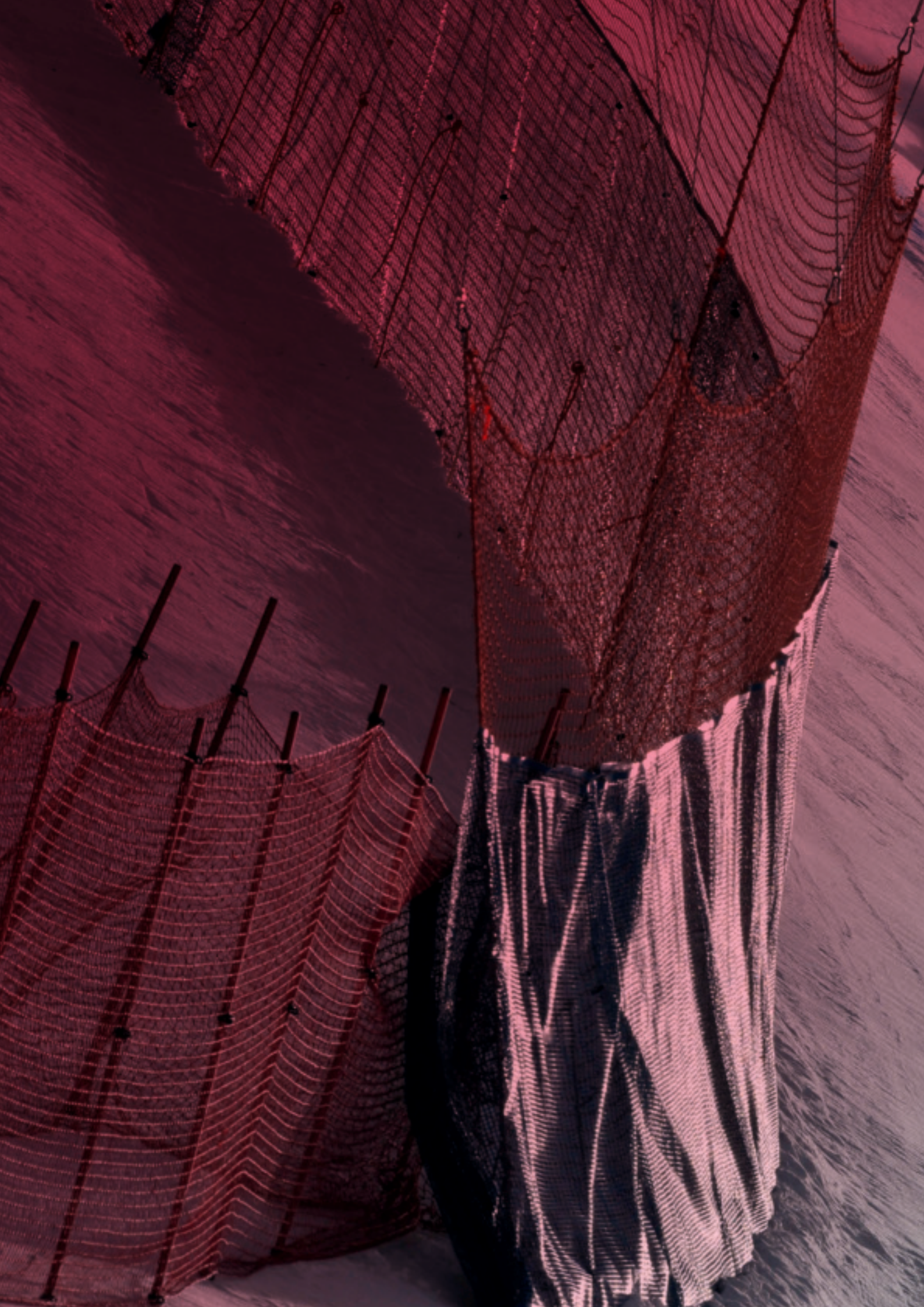



FEATURES | HELMETS

LIGHT SHELL

We use the LIGHT SHELL for all InMould helmets with polycarbonate outer shells. Here the shock-absorbing EPS foam core is injected directly into the PC shell. The two components bind together and offer perfect protection and a low weight.

RESPIRO CORE

Our new RESPIRO core is used in the helmets of the STIVOT and VENTOR series. This EPS foam core is perforated throughout and this construction ensures a pleasantly ventilated microclimate inside the helmet, coupled with a low weight.

HYBRID SHELL

Our new Hybrid Shell construction combines the advantages of the robust ABS technology with the lightweight In-Mould construction. Thus, we develop lightweight, extremely robust and durable helmets. Hybrid Shell helmets may be constructed slimmer, a fact that adds to the stylish look.

LOWER MICROSHELL



The helmet body is also coated with polycarbonate in order to avoid scratches and dents in the foam.

TWIST STOP GOGGLE RETAINER



The Twist stop goggle retainer will keep the goggles exactly where they belong and avoids any slipping of the straps.

CONSTRUCTION

REMOVABLE BRIM



For some, it is a matter of style – for others, it is a matter of function: the removable brim gives the helmet a cap-like style and serves as a sun, snow or rain protection. The integrated vents ensure that the moisture of the goggles is transported away and that the goggles do not fog up.

TOUGH SHELL

The classic dual construction made up of the ABS outer shell and the shock-absorbing EPS foam core is matchless in terms of longevity and impact strength. For this reason we use this construction for our STIVOT series helmets and for all the helmets in our rental range.

CONEHEAD SANDWICH CORE

The particular, pyramid-like structure of the two-layer foam ensures that shocks are better absorbed and that the impact energy is extensively distributed over the helmet. An innovative construction by means of which we brake the mold in the design of winter sports helmets.



MONO CORE

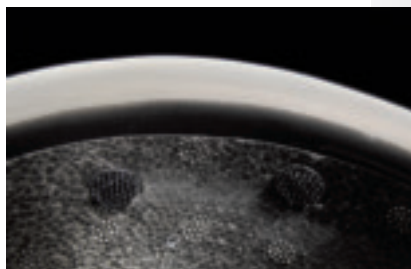

In case of the In-Mould technology, the shock absorbing inner layer is injected through the hard outer polycarbonate layer creating a coherent whole. This provides perfect protection while still featuring a reduced weight.

VENTILATION

ADJUSTABLE DUAL ZONE VENTILATION



The ventilation in the two air ducts may be optimally adjusted independently from each other by means of two slide controls at the front and back side of the helmet.

ADJUSTABLE VENTILATION



The opening of the ventilation ducts on the top of the helmet may be adjusted continuously by means of a slide control.

THERMAL VENTILATION

Thermal Ventilation is our automatic ventilation system which leads warm air away from the head to the outside without allowing any cold air to the inside.

LINING

BEANIE LINER

The soft Microfleece material of the Beanie Liner adapts perfectly to the head and thus avoids any bruises and the unpleasant entering of cold air. Molded-in mesh zones let heat and moisture escape to the outside and, together with the ventilation system, ensure a pleasant head climate.

WOMEN SPECIFIC BEANIE LINER

Women have a different head shape than men. This is why we developed a Beanie Liner for women which is exactly adapted to the anatomy of the female head. This was achieved by means of two differently thick padding zones made of soft Microfleece.

INTEGRATED LINER WINDSHIELD

If it is very cold or stormy, the forehead above the goggles may be exposed to extreme temperatures. The liner windshield integrated in the Beanie Liner may simply be folded down if required and will thus close the gap between helmet and goggles. A small feature with great effect.

VENT DAMS

On cold days on the slope, the vents of the Thermal Ventilation may easily be closed by means of the Vent Dams.

AUDIO SOLUTION WITH VOLUME CONTROL

Our audio-helmets are equipped with high-quality earphones in the soft ear pads. The volume control integrated in the earphone cable provides for easy handling.

AGION™ ANTIMICROBIAL LINING

We use an antimicrobial Agion™ material for our liners. The combination of disinfecting silver ions and a preceramic coating makes the surface antimicrobial and the helmet remains odorless.

PERFORATED SOFT MICROFLEECE



The soft Microfleece material has two functions: it feels pleasant on the skin, absorbs moisture and transports it away from the head.

SOFT VELVET



A soft and at the same time durable material which absorbs the moisture and thus keeps the head dry.

FEATURES | HELMETS & PROTECTION

EARPADS/NECK

HEIGHT ADJUSTABLE EARPADS



Due to the fact that not all people have their ears at the same height, we developed a patented system for the height adjustment of the ear pads. This system guarantees an optimal hearing and perfect fit of the helmet. Of course you can completely remove our ear pads including Neckgator on warm days or for cleaning purposes.

3D FIT

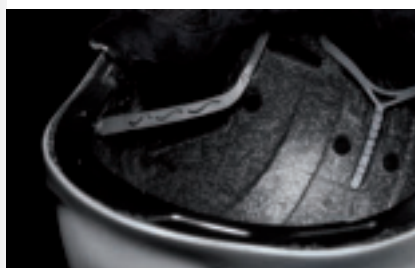

Head 3D Fit allows an exact horizontal as well as vertical adjustment of the helmet to the shape of your head.

2D FIT



The size adjustment system may be varied horizontally in order to individually adjust the helmet to your head.

FITTING HELMET/BODY PROTECTION

FIND THE RIGHT SIZE

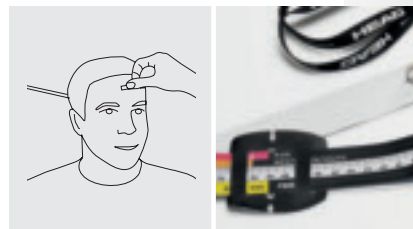

Measure your head circumference with a tape measure which you apply above your ears. You will find the correct helmet size for your head circumference in the table below.

PUTTING ON THE HELMET AND ADJUSTING THE CHIN STRAPS

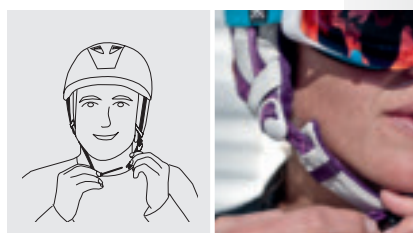

The helmet shall sit tightly on your head directly above your eyebrows. Adjust the two chin straps so that they solidly fix and hold the helmet.

CHECK FIT WITH GOGGLES

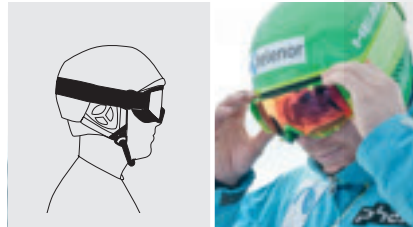

In order to check the perfect fit of the helmet, please put on your goggles. There should be no gap at all or an only small gap between the upper edge of your goggles and the helmet.

BACK PROTECTOR

A back protector may only provide you with full protection if you have chosen the correct size and adjusted it to your body.

ADJUST THE PROTECTOR



Apply the protector and tighten the straps. The protector shall sit tight against the body without limiting the freedom of movement.

SIZING HELMET/BODY PROTECTION

HELMETS

ADULT	HELMETS
XS - S	52.0 - 55.0 CM
M - L	56.0 - 59.0 CM
XL - XXL	60.0 - 63.0 CM
KIDS	HELMETS
XXS - XS	49.0 - 52.0 CM
S - M	53.0 - 56.0 CM

SIZECHART BODY PROTECTION

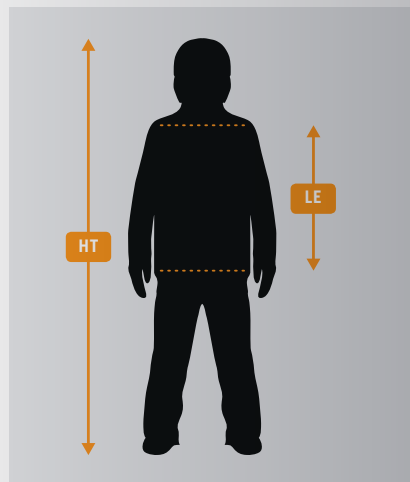

FLEXOR SERIES







MEN/UNISEX		FLEXOR VEST/FLEXOR UNIT			
SIZE	HT		LE		
	CM	"	CM	"	
S	168	66	43	17	
M	176	69	46	18	
L	186	73	48	19	
XL	192	76	49	20	
XXL	196	77	50	20	
WOMEN		FLEXOR WOMEN'S VEST			
SIZE	HT		LE		
	CM	"	CM	"	
XS	156	61	41	16	
S	164	65	43	17	
M	172	68	46	18	
L	180	71	50	20	
JUNIOR		JR FLEXOR VEST/JR FLEXOR UNIT			
SIZE	HT		LE		
	CM	"	CM	"	
116	116	46	33	13	
128	128	50	35	14	
140	140	55	37	15	
152	152	60	38	15	
164	164	65	43	17	

PRODUCT OVERVIEW









HEAD®







RACE

	WORLD CUP REBELS i.GS RD	PAGE 7
	WORLD CUP REBELS i.GS RD M/W	PAGE 7
	WORLD CUP REBELS i.SL RD	PAGE 7
	WORLD CUP REBELS i.DH RD	PAGE 8
	WORLD CUP REBELS i.SG	PAGE 8
	WORLD CUP REBELS i.SL	PAGE 9
	WORLD CUP REBELS i.SPEED	PAGE 9

PERFORMANCE

	i.SUPERSHAPE TITAN	PAGE 23
	i.SUPERSHAPE RALLY	PAGE 23
	i.SUPERSHAPE MAGNUM	PAGE 24
	i.SUPERSHAPE SPEED	PAGE 24
	PRESTIGE	PAGE 25
	LIMITED	PAGE 25

ALLRIDE



	REV 105	PAGE 37
	REV 90	PAGE 37
	REV 85 PRO	PAGE 37
	REV 80 PRO	PAGE 38
	REV 78	PAGE 38
	REV 75	PAGE 38

	INTEGRALE 009	PAGE 39
	INTEGRALE 007	PAGE 39
	INTEGRALE 005	PAGE 39

FREESKI











	TURBINE 125	PAGE 52
	CYLCIC 115	PAGE 52
	COLLECTIVE 105	PAGE 53
	VENTURI 95	PAGE 53
	PROSTELLAR 98	PAGE 59
	GALACTIC 84	PAGE 59
	NEBULA 78	PAGE 59
	THE CADDY	PAGE 65
	OBLIVION #2	PAGE 66
	THE SHOW	PAGE 66

WOMEN

	MYA NO.10	PAGE 79
	MYA NO.9	PAGE 79
	MYA NO.8	PAGE 79

	MYA NO.7	PAGE 82
	MYA NO.6	PAGE 82
	MYA NO.5	PAGE 83
	MYA NO.4	PAGE 83
	MYA NO.3	PAGE 83

JUNIOR

	WORLD CUP iSG RD	PAGE 98
	WORLD CUP GS TEAM	PAGE 97
	WORLD CUP SL TEAM	PAGE 97
	WORLD CUP iRACE	PAGE 98
	SUPERSHAPE LR	PAGE 98
	SUPERSHAPE TEAM LR	PAGE 98
	MYA NO.1	PAGE 99
	PEZ TEAM	PAGE 99
	ETHAN TOO	PAGE 106
	THE CADDY JR.	PAGE 106
	RESIDUE	PAGE 107
	BIG HEIR	PAGE 107
	SOUPHEAD LR	PAGE 107

RACE



RAPTOR B2
PAGE 11



VECTOR 125
PAGE 30



CUBE3 12
PAGE 43



THE SHOW 1
PAGE 68



ADAPTEDEGE 100 MYA
PAGE 84



RAPTOR B5 RD
PAGE 100



EDGE J3
PAGE 111



RAPTOR B3
PAGE 11



VECTOR 115
PAGE 30



CUBE3 10
PAGE 43



THE SHOW 2
PAGE 68



ADAPTEDEGE 90 MYA
PAGE 84



RAPTOR 90 RS
PAGE 100



EDGE J2
PAGE 111



RAPTOR 130
PAGE 12



VECTOR 105
PAGE 30



CUBE3 8
PAGE 43

WOMEN



RAPTOR 110 MYA
PAGE 80



NEXTEDEGE 80 MYA
PAGE 84



RAPTOR 70
PAGE 101



EDGE J1
PAGE 111



RAPTOR 115
PAGE 12



ADAPTEDEGE 100
PAGE 40

ALLRIDE



RAPTOR OVERKILL
PAGE 55

FREESKI



CHALLENGER AT
110 MYA
PAGE 80



NEXTEDEGE 70 MYA
PAGE 84



RAPTOR 50
PAGE 101



SOUPHEAD 2
PAGE 112

PERFORMANCE



CHALLENGER AT 130
PAGE 29



ADAPTEDEGE 90
PAGE 41



VENTURE FR 130
PAGE 61



DREAM 100 MYA
PAGE 81



CUBE3 12 MYA
PAGE 85



RAPTOR 40
PAGE 101



SOUPHEAD 1
PAGE 112



CHALLENGER AT 120
PAGE 29



NEXTEDEGE 80
PAGE 41



VENTURE FR 120
PAGE 61



DREAM 90 MYA
PAGE 81



CUBE3 10 MYA
PAGE 85



RAPTOR CADDY 50 JR
PAGE 106



CHALLENGER AT 110
PAGE 29



NEXTEDEGE 70
PAGE 41



RAPTOR OBLIVION
PAGE 67



DREAM 80 MYA
PAGE 81



CUBE3 8 MYA
PAGE 85



RAPTOR CADDY 40 JR
PAGE 106

JUNIOR

RACE



FREEFLEX PRO 20 X RD
ART.N°: 100500



FREEFLEX PRO 20 X RS
ART.N°: 100501



FREEFLEX PRO 18 X
ART.N°: 100502



FREEFLEX PRO 16 X RD
ART.N°: 100503
FREEFLEX PRO 16 X RD STIFF
ART.N°: 100504



FREEFLEX PRO 16
ART.N°: 100506



FREEFLEX PRO 14
ART.N°: 100508



FREEFLEX PRO 11
ART.N°: 100510

PERFORMANCE



PRD 14 S
ART.N°: 100513
PRD 14 S WIDE 88
ART.N°: 100514



PRD 14
ART.N°: 100515



PRX 12 S
ART.N°: 100522
PRX 12 S WIDE 88
ART.N°: 100523

ALLRIDE



PRD 12
ART.N°: 100520
PRD 12 WIDE 88
ART.N°: 100521



PR 11
ART.N°: 100527
ART.N°: 100384
ART.N°: 100528



PR 11 WIDE 90
ART.N°: 100526



LX 12
ART.N°: 111650
ART.N°: 111544



SX 10
ART.N°: 111435
ART.N°: 111436

FREESKI



AAADRENALIN 16 SHORT
ART.N°: 111604
AAADRENALIN 16 LONG
ART.N°: 111605



AAADRENALIN 13 SHORT
ART.N°: 111606
AAADRENALIN 13 LONG
ART.N°: 111607



AAAMBITION 12
ART.N°: 111612
ART.N°: 111610



AAATTACK 16
ART.N°: 111615



AAATTACK 13
ART.N°: 111617
ART.N°: 111618
AAATTACK 13 WIDE 97
ART.N°: 111616



AAATTACK 13LT
ART.N°: 111619



PEAK 18
ART.N°: 111620



PEAK 11 WIDE 90
ART.N°: 111624
PEAK 11 FAT 115
ART.N°: 111625

WOMEN



MYA 12 PRD
ART.N°: 100535

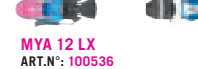

MYA 12 LX
ART.N°: 100536



MYA 10 PR
ART.N°: 100539
ART.N°: 100540



MYA 10 PR WIDE
ART.N°: 100538



MYA 9 LRX
ART.N°: 100543
ART.N°: 100544



SX 9 JR RACE
ART.N°: 100547



LRX 7.5 AC
ART.N°: 100436



LRX 4.5 AC
ART.N°: 100441



PEAK 7.5 AC WIDE 90
ART.N°: 111627



PEAK 4.5 AC WIDE 84
ART.N°: 111628



SX 7.5 AC
ART.N°: 111548
ART.N°: 111654
ART.N°: 111549



SX 4.5 AC
ART.N°: 111554
ART.N°: 111555
ART.N°: 111556
ART.N°: 111557
ART.N°: 111569

JUNIOR

RACE



WORLD CUP SUPER G
PAGE 14



WORLD CUP SL
PAGE 14

PERFORMANCE



SUPERSHAPE VIP
PAGE 31



CARBON PRESTIGE
PAGE 31



HEAD CLASSIC
PAGE 31

ALLRIDE



MULTI S
PAGE 44



MULTI
PAGE 44

FREESKI



3350 VARIO TWO PIECE
PAGE 62



3312 VARIO THREE PIECE
PAGE 62



AERO
PAGE 67

WOMEN



MYA WHITE
PAGE 86



MYA BLACK
PAGE 86

JUNIOR



WORLD CUP SG JR
PAGE 102



SUPERSHAPE TEAM
PAGE 102

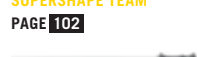

AERO TEAM
PAGE 109



MYA GIRL
PAGE 109

RACE



REBELS TRAVELBAG
PAGE 19



REBELS RACING BACKPACK
PAGE 19



REBELS SKIBAG 4 PAIRS
PAGE 19



REBELS DOUBLE SKIBAG
PAGE 19



HEATABLE BOOTBAG
PAGE 19

ALLRIDE



SKI TRAVELBAG
PAGE 47



SINGLE SKIBAG
PAGE 47



DOUBLE SKIBAG
PAGE 47



SKI DAYPACK
PAGE 47



BOOT BAG
PAGE 47



BOOT BACKPACK
PAGE 47

FREESKI



SKI FREERIDE BACKPACK
PAGE 71



PEAK FELLOW
PAGE 72



TRAVEL BAG SM
PAGE 73



LEARNJET
PAGE 73



STREET BACKPACK
PAGE 73

WOMEN



WOMEN'S TRAVELBAG
PAGE 90



WOMEN'S SKIBAG
PAGE 90



WOMEN'S BOOT BAG
PAGE 90

RACE



STIVOT RACE
PAGE 15

ALLRIDE



STIVOT AIR
PAGE 45



REBEL AUDIO
PAGE 70



TIKA
PAGE 88



STIVOT YOUTH
PAGE 109

PERFORMANCE



SENSOR BT RUNTASTIC
PAGE 33



ECHO
PAGE 45

WOMEN



CARMA
PAGE 87



ELA
PAGE 89



JOKER
PAGE 113

FREESKI



PRO
PAGE 69



GRACE
PAGE 87



CLOE
PAGE 89



STAR
PAGE 113



CREST
PAGE 34



SENSOR
PAGE 34



REBEL
PAGE 69



STIVOT AIR
PAGE 88

JUNIOR



STIVOT RACE YOUTH
PAGE 103

RACE



HORIZON RACE
PAGE 16

FREESKI



HORIZON
PAGE 70

RACE



FLEXOR UNIT RACE
PAGE 17

ALLRIDE



FLEXOR UNIT
PAGE 46

JUNIOR



FLEXOR JR UNIT RACE
PAGE 104

PERFORMANCE



STIVOT
PAGE 35

JUNIOR



STIVOT YOUTH
PAGE 103

PERFORMANCE



FLEXOR VEST
PAGE 35

WOMEN



FLEXOR WMN VEST
PAGE 90



FLEXOR JR UNIT
PAGE 110

ALLRIDE



NUKE
PAGE 46



NINJA
PAGE 113



FLEXOR JR VEST
PAGE 110

FEATURE DESCRIPTIONS | SKIS



AIRCOAT SUPERLIGHT TWINTIP CONSTRUCTION: For kids who want to spin their first 7, we found the perfect fiberglass for catching air - Aircoat. This twin tip construction is designed specifically for the lighter weight skier to become the skier of tomorrow.



ALLRIDE ROCKER: Rocker that is equally at home on bulletproof snow as it is in powder. This profile uses early rise in the tip with regular camber throughout the rest of the ski. 20% rocker - 80% camber.



DIECUT UHM C BASE: This durable workhorse base material is dedicated to all country skiing. Diecuts are added for flare.



DIFFUSOR: Ridges in the tail of tail of our skis that direct skis that direct energy to the end of the ski. Like the diffuser on cars, this sticks the ski into the snow at the end of the turn and boosts skiers all over the mountain.



E BASE BLACK: Basic black never goes out of style, and it's always durable. Easy gliding is everyone's friend.



ERA 2.0: ERA 2.0 is the little brother of ERA 3.0 and is everything 3.0 has to offer as far as design, performance and geometry integration, but without the addition of "Rebound" with its piezoelectric Intellifibers.



ERA 3.0: A masterful blend of three independently important technologies to make the ultimate allcountry skis. **ROCKER + RADIUS + REBOUND = ROCKER DONE RIGHT.**



ERA 3.0 S: "Sports version" of ERA 3.0 with a multifaceted ski designed with race innovation and inspiration, yet now with the addition of Rocker, Radius and Rebound. Totally new skiing experience with 10% rocker and 90% camber.



HIGHLY TRANSPARENT UHM BASE: A high-density, determinedly durable base that allows gorgeous graphic details to shine through. The perfect combination of fashion and function.



INTELLIGENCE™ TECHNOLOGY: Piezoelectric fibers that absorb vibrations at the speed of light. As you ski faster, the Intelligence™ stiffens the ski to increase stability. It adapts to where and how you ski.



INTELLIGENCE™ CHIP TECHNOLOGY: With Intelligence™ Chip Technology the electrical energy produced by the Intellifibers is not just recycled but accumulated and released bit by bit through a pre-programmed chip.



ISS – INDEPENDENT SUSPENSION SYSTEM: Elastomeric vibration killers located in the tip, tail and underfoot. The elastomers quiet the vibrations that are commonly associated with rockered skis. Underfoot, the vibrations are dampened to provide the skier with a smooth ride.



JUNIOR POWER FRAME: A geometric ski shape that provides structural strength to the outer edges of the ski through geometric design, as opposed to altering the core material or density of the ski. Also, for kids it looks cool and feels different than a standard flat ski.



KERS: A computerized piezoelectronic device that stores ski energy and releases it at the end of each turn. In reality, it's a turbo charger for your skis.



METAL POWER TUBES: Premium features for premium skis. Metal power tubes enable a perfect power transmission from edge to edge. Maximum performance and grip right underneath your foot. Just as you want it!



NANO TECH SURFACE: A permeable nonstick surface with similar molecular compounds and structure to that of a skis base material. This allows you to wax and alter the surface with standard ski wax to assure a light-weight nonstick and snow free surface for your trek up.



PNP ROCKER: Very subtle tip and tail rise with regular camber construction underfoot. PNP Rocker provides a rider a smoother turn initiation as well as reduced edge contact to seamlessly butter into tricks and initiate spins. 30% rocker and 70% camber.



POWER CARBON JACKET: A PU injected core that is wrapped in a layer of carbon fibers. This lightweight construction allows for a soft longitudinal flex coupled with a stiff, responsive torsional flex. It delivers an easy-to-use but impressively responsive ski.



POWER SIDEWALL JACKET: An innovation in ski construction that combines the well known fiber jacket construction with ABS sidewalls. A lightweight ski with easy skiing performance including sidewalls for better dampening, shock absorption and edge grip. Performance at its best for its great target group.



RACE STRUCTURED UHM C BASE: The highest quality, fastest base and finish known to man. The technicians who build the skis for our World Cup Rebels use the same material and machines to put this scary fast base and structure into your skis.



RD RACING TOP SHEET: A thinner topsheet material designed to maximize responsiveness. Exclusive to our RD skis.



REBEL CAMBER: Some years ago it was years ago, it was rebellious to have rocker. Now, it's rebellious to have camber. With Rebel Camber, we feature explosive acceleration and excellent edge grip for the World Cup Rebel inside you.



SANDWICH CAP CONSTRUCTION: We take the basic framework from the world cup sandwich and place a cap that just wraps over the top edge of the sidewall to make the ski more suitable for all mountain skiing. Bomber construction with a rounded top edge makes for one incredible allcountry ski.



SANDWICH TWINTIP CONSTRUCTION: We blend a full vertical laminate wood core for durability and add our bomber Independent Suspension System for killing chatter. Pipe, park, big mountains, whatever, bring 'em on and let this construction rip.



STRUCTURED SURFACE: An extra-durable topsheet with a structured exterior. Designed to hold up against the most extreme abuse.



STRUCTURED UHM C BASE: The same high quality material used in HEAD's world-leading race skis is used here. Different structured running base for all conditions.



TNT ROCKER: Tip and tail rocker combined with regular camber underfoot. This combination creates a surfy feel in powder while maintaining hard snow versatility. 40% rocker - 60% camber.



TTS (TIP & TAIL STABILIZER SYSTEM): A ski with reduced vibration and increased dampening and a system to increase torsional strength all while at the same time reducing swing weight.



TUFFWALLS: Impact resistant ABS sidewalls. While maintaining responsiveness, Tuffwalls are designed to take a beating.



TWINTIP CONSTRUCTION: A vertically laminated wood core, surrounded by a sock of fiberglass and covered by a durable topsheet. This forgiving twin tip construction is slightly softer than our sandwich twin tip layout, making it better for learning pipe and park tricks.



UHM C BASE: Our highly durable base material for getting the job done well. Not flashy, but steady and stable. The kind of base that will last for years.



WOOD CORE CAP CONSTRUCTION: A vertically laminated wood core, surrounded by a sock of fiberglass and covered by a durable topsheet. This forgiving construction is slightly softer than our sandwich cap making it ideal for ramping up the learning curve.



WORLD CUP SANDWICH CONSTRUCTION: The basic construction invented by Howard Head in the 1940's, perfected and hand built by the finest ski technicians in the modern world. The vertical laminate wood core is embraced by speedfreak phenolic sidewalls and the finest Titanal. This is the fastest construction on the planet. Period.

FEATURE DESCRIPTIONS | BINDINGS



ABS – ANTI BLOCKING SYSTEM: The exclusive TYROLIA technology of the ABS continuous band allows the boot to move out of the binding almost without any friction, hence delivering maximum safety in case of icing up, dirt and boot wear.



AERO TOE: The Performance Toe which is used in alpine ski racing. Due to higher release forces vertically than horizontally these toes hold up to the high backward lean forces occurring in racing. Our athletes trust in them!



AFS – ANTI FRICTION SLIDER: New weight optimized adapter for gliding insert at Power Bindings for reduced friction, constant release values and maximum safety.



AFS JUNIOR: The innovative mechanical Anti Friction Slider (AFS) automatically adjusts to the boot sole height, compensating A/C standards as well as height differences due to icing up, dirt or boot wear.



AFS METAL: The 68 mm wide slider plus a stainless steel gliding element provides constant release values and results in a broader contact area to the ski boot sole.



AT TOE: The Alpine Touring (AT) Toe can be easily adjusted to alpine and touring boot norms and it secures constant release values also with rubber soles.



BRAKES: HEAD offers brakes with different width for optimal fit on wider skis and fat skis up to 150 mm ski width in the brake area. Some binding models are delivered without brake – “w/o brake” – to avoid brake exchange later on.



CLIMBING AID: The climbing aid with its different climbing positions, which can be operated without stepping out of the binding, provides excellent balance and effortless climbing.



DURA-COATING: Scratch resistant electrostatic powder coating provides environmentally friendly design, optimal durability and a variety of possible colors and color combinations.



FREEFLEX PRO: Best performance enabled by the innovative Freeflex Pro System. The free-gliding heel allows the ski to bend through unimpeded and to retain its natural dynamics. Due to the reduced stand height, the Freeflex band is now much closer to the ski boot. Constant release values reduce the risk of injury and ensure safe ski steering.



FR PRO TOE: The Freeride (FR) Pro Toe can be easily adjusted to different boot sole heights. Its horizontal spring reflects the modern architecture of the AAA-Series.



FULL DIAGONAL: Intelligent 180° release both horizontally and vertically of the Diagonal Toe and therefore ensures maximum safety in backward twisting-fall situations.



LIGHT DIAGONAL HEEL: The Light Diagonal Heel provides maximum safety with a 150° release. Thus, pressure on the knee and ligaments upon twisting forward falls and the risk of injury are reduced.



LITERAIL: LiteRail is the ultimate system for both retail and the rental sector as well. LiteRail is demo suitable, high end Rental suitable, season rental suitable and can be used for all flat skis. Due to three different mid parts, LiteRail covers boot sole lengths ranging from 199 to 347 mm. Covering this large mounting range LiteRail is perfectly suited for kids, juniors as well as adults.



LX TOE: The performance oriented LX toe defines stability and power, much as a strong and tough bull would extremely durable and absolutely reliable.



POWERRAIL: The unrivalled technology for retail, demo & rental by the well-received rail system on a modular basis provides easiest handling, maximum flexibility, optimized performance, perfect match, more stability and durability.



RACE DIAGONAL: Diagonal Toe tuned for racing purposes. Due to its higher release force vertically than horizontally, it holds up to the high backward lean forces in racing.



RACE LITE HEEL: The lighter variant of the Race Pro Heel for young up-and-comers and speed stars of tomorrow.



RACE PRO HEEL: The stand height was reduced according to the actual FIS rules. An increased contact area reduces friction and provides constant forward pressure in all skiing situations.



SL LITE HEEL: Weight optimized toe for junior and light-weight skiers with proven safety features of the HEAD/TYROLIA binding technology.



SOLID COLORED: Solid colored plastic parts are not coated with a separate color layer. Instead, the color has been added to the plastic granulate already. Thus, those parts are absolutely scratch resistant and durable but less color options are available.



SX HEEL: Based on new kinematics the ski boot is precisely secure in the binding. This ensures exact and more direct power transmission from boot to edge.



SX JR. HEEL: The new junior heel with improved kinematics to increase safety and performance for junior skiers.



SX JUNIOR TOE: The innovative kinematics of HEAD's LX and SX adult line provide advantages in performance and stability for the SX Junior line for young speedsters as well.



SX KID HEEL: The SX Kid heel provides the little ones with the best in the latest technologies and safety standards for binding innovation and integrates the new kinematics for the younger set, too. Because safety is paramount, always.



SX KID TOE: With the SX kid toe for up-and-comers and integrated innovative LX/SX kinematics ski steering now requires even less effort.



SX TOE: The kinematic improvements are reflected in the product design of the SX toe as well. With its high cheek bones it reminds of a fox – smart, sly, agile and very clever.



TEFLON WIDE: The wide Teflon® insert ensures better force transmission, more stability and therefore optimal performance.



TELESCOPIC TUBE: With only one binding model it is possible to cover the entire range of different sole lengths (from 260 mm up to 350 mm).



TRP – TYROLIA ROLLER PINCHER SYSTEM: The TYROLIA Roller Pincer Toe System (TRP System) of the HEAD bindings with its four rollers and gliding inserts ensure a 180° release and exact centering of the ski boot. The TRP system reduces the load on knees and ligaments and improves performance considerably.

BASES/PLATES



JUNIOR RACE PLATE 11: It provides an additional stand height of 11mm and covers boot sole lengths from 251-332 mm. Oblong Holes and a two-piece flex system support Freeflex and maintain ski flexibility. It provides increased torsion stability, control and edge grip although being super light. Pre drilled mounting holes make it easier to mount the binding without drilling.



POWERRAIL PRO BASE: The high-end variant, PowerRail Pro, is equipped with an additional Freeflex band which links both toothed areas at the toe and the heel side of the base. Therefore, toe and heel piece can glide on the base unhindered. This additional “Double Freeflex Function” ensures fewer impediments of the natural ski flex, constant release values and better edge grip.



POWERRAIL STANDARD BASE: The standard PowerRail Base consists of a monoblock base body, a cover, and an inlaid toothed area which can be color matched to the ski design. For unhindered natural ski flex, the base is secured by one fixed pair of screws, and three free-gliding pairs of screws. This ensures the base safely adapts to the flex of the ski.



SPEEDFLEX PLATE: The new free gliding speedflex plate provides an additional stand height of 13 mm and the impact on ski flex is greatly reduced. Dampener, oblong holes and the new designed super flex system support Freeflex and maintain ski flexibility. Additional metal brackets provide increased edge grip, torsion stability and control.